



**Apeks**  
**Second Stage Regulator**  
**Service & Repair Manual**

for Authorized Sea Quest Service Centers

---

# Contents

<b>Introduction .....</b>	<b>3</b>
<b>Safety Precautions .....</b>	<b>3</b>
<b>General Procedures .....</b>	<b>3</b>
Maintenance Schedules .....	3
Initial Inspection and Pre-Test .....	3
Infrequently Used Regulators .....	4
Work Area & Required Tools .....	4
O-ring Removal .....	4
Lubrication .....	4
<b>Table 1 – Recommended Tools .....</b>	<b>5</b>
<b>Table 2 – Lubricant and Cleaner .....</b>	<b>6</b>
<b>Disassembly Procedures .....</b>	<b>7</b>
<b>Cleaning &amp; Inspection Procedures .....</b>	<b>10</b>
<b>Reassembly Procedures .....</b>	<b>12</b>
<b>Final Adjustment and Testing Procedures .....</b>	<b>15</b>
External Leak Test .....	16
Subjective Breathing Test .....	16
<b>Table 3 – Troubleshooting .....</b>	<b>17</b>
<b>Repair &amp; Replacement Parts .....</b>	<b>18</b>
<b>Schematic Drawing .....</b>	<b>19</b>

## INTRODUCTION

Apeks regulators are the product of many years of research and development. Apeks has utilized proven materials and design to maximize reliability and performance.

This manual is intended only as a guide for the experienced repair person that has completed a Sea Quest/Apeks service and repair seminar. It is not intended to educate inexperienced repair personnel or the consumer in all aspects of Apeks regulator repair. Sea Quest/Apeks repair seminars are available periodically to Authorized Sea Quest Dealers. Servicing and repair at the repair shop level mainly involves cleaning, inspection, adjustment, and replacement of worn parts.

If you have any questions on any of the procedures, inspections, or tests, please contact Sea Quest at:

(877) 253-3483.

## SAFETY PRECAUTIONS

This manual provides step by step instructions for the disassembly, inspection, cleaning, reassembly, and testing of the Apeks second stage regulator. It is recommended that all steps are followed in the order given. Read each section completely PRIOR to beginning work described in that section. This will familiarize the repair technician with important precautions to take during each service procedure.

Pay close attention to all WARNINGS, CAUTIONS, and NOTES that are intended to draw your attention to items of importance.

### Definition of Warnings, Cautions, and Notes:



#### WARNING

Indicates a procedure or situation that may result in serious injury or death for either the technician or the user if instructions are not followed correctly.



#### CAUTION

Indicates any situation or technique that may result in potential damage to the product, or render the product unsafe if instructions are not followed correctly.



NOTE Is used to emphasize important points and tips.

## GENERAL PROCEDURES

### MAINTENANCE SCHEDULES

Regulators are subjected to a variety of environmental elements that over time can affect the performance of the product. As an Authorized Sea Quest/Apeks Dealer you are advised to inform your staff and customer that Sea Quest/Apeks regulator require complete servicing at least once a year. Under certain circumstances a complete servicing is required every 3-6 months. Some of these circumstances are:

- Frequent or improper use
- Inadequate routine freshwater rinsing
- Regulator use in dirty or polluted waters
- Rental use
- Regular use in chlorinated (pool) water

Recommended maintenance schedules are based on average use under normal conditions and assume that recommended preventative maintenance and storage procedures have been followed as outlined in the Sea Quest/Apeks owner's manuals.

Advise the customer that any adjustments or servicing on Sea Quest/Apeks regulators must be performed by Sea Quest, or by an Authorized Sea Quest/Apeks Dealer that has attended a Sea Quest authorized service seminar.

### INITIAL INSPECTION AND PRE-TEST

Prior to beginning the servicing of the regulator, a preliminary inspection and pre-test of the entire breathing system is recommended. This will help the repair technician identify any problems that may affect the second stage.

Preliminary inspection should include:

- **First stage inlet filter** - If the first stage inlet filter is discolored, the entire regulator should be completely serviced. Deposits of rust (red powder) or aluminum oxide (gray powder) on the filter may indicate that water has entered the SCUBA cylinder and caused internal cylinder corrosion. The customer should be notified that their SCUBA cylinder(s) may be in need of visual inspection, cleaning and testing. Advise your customers to regularly inspect the inlet filter for any discoloration or corrosion.
- **High pressure (HP) and low pressure (LP) hoses** - Inspect the hoses carefully for any evidence of cracking, tearing, or excessive abrasion of the outer rubber covering. Remove all of the hose protectors and examine the area around the metal fittings for any damage to the hose. Inspect the fittings for signs of excessive corrosion.

- **All chrome plated parts** - Inspect for any excessive corrosion indicating weak or absent chrome plating. Also look for any signs of peeling or flaking of the chrome plating.

- **Regulator pre-test** - A regulator pre-test should include all tests outlined in the test section for each regulator. A pre-test will assist the technician in determining if there are any specific performance deficiencies not mentioned by the customer.

### INFREQUENTLY USED REGULATORS

Do not assume that the regulator is in good condition because of infrequent use or because it has been in storage. Deterioration of the O-rings and corrosion can still occur under these circumstances.

### WORK AREA & REQUIRED TOOLS

Servicing and repair of the regulator should be carried out in a clean well lighted work area. As each regulator is disassembled all parts should be kept separate from parts of other regulators. Some special tools are required for proper disassembly and reassembly. Please see Table 1 (page 5) for a list of these tools.

### O-RING REMOVAL

When removing O-rings, care must be taken to not damage the regulator surfaces in contact with the O-rings. Tools used to remove O-rings must not have any sharp edges or points that could scratch metal sealing surfaces. Sea Quest strongly recommends that all O-ring removal tools should be made of either brass or plastic.

### LUBRICATION

O-rings should be lubricated with an approved compound (please refer to Table 2 for proper lubricants). O-rings should be lubricated only with a very light film of grease. Do not use spray (aerosol) lubricants under any circumstances. The aerosol propellant may damage the plastic and rubber components of the regulator, and the lubricant will quickly evaporate, providing little or no lasting benefit.

#### **WARNING**

Do not use any petroleum based lubricants or products, or any aerosol sprays to lubricate or clean any part or component of Apeks regulators. The petroleum base or propellant gas may attack or weaken the plastic or rubber parts. Refer to Table 2 for approved lubricants.

#### **WARNING**

Apeks regulators are intended for use in water temperatures warmer than 45°F (7°C). Colder water may cause regulators to be more sensitive to a freeflow condition and can lead to a situation that requires an appropriate response to prevent serious injury or death. Users of Sea Quest regulators are advised to ensure that they are adequately trained to deal with a regulator in a freeflow condition or an out-of-air emergency before attempting to dive in a cold water environment.

**TABLE 1**  
**RECOMMENDED TOOLS - APEKS SECOND STAGES**

<b>Sea Quest Part No.</b>	<b>Description</b>	<b>Application</b>
5116236	Seal/seat extractor	Removal/ installation of seat crown
AT31	Case Cover Tool (TX50/40/T20)	Removal/installation of case cover
AT42	Case Cover Tool (TX100)	Removal/installation of case cover
N/A	5mm hex key & hex key socket	Removal/installation of blanking plugs
N/A	11/16" open end wrench/ hex socket	Removal/ installation of LP hose, retaining nut
N/A	0-120 inch-lbs torque wrench	Small fittings
1116-10	I.P. test gauge	Intermediate pressure testing
9440-22	O-ring tools	O-ring removal & installation
41532	LP air nozzle	Parts drying
N/A	Magnifier w/ illumination	Sealing surface inspection
N/A	Ultrasonic cleaner - 60HZ, 1.3 amp	Brass & stainless steel parts cleaning

**TABLE 2**  
**LUBRICANT AND CLEANER**

Lubricant / Cleaner	Recommended Type	Application	Source
Christo-Lube	MCG-111	All O-rings, threaded metal parts as indicated	Lubrication Technologies 310 Morton Street Jackson, OH 45640 800-477-8704
Chemical Bath Solution	Chromesafe	Chrome-plated brass, brass, and stainless steel parts	Sea Quest/ Aqua Lung America P/N 0201-05
	50/50 mix distilled white vinegar and water	Chrome-plated brass, brass, and stainless steel parts	Local grocery stores
Liquid dishwashing detergent (diluted with warm water)	Joy®	General cleaning solution, degreaser for plastic and rubber parts, leak detection	Local grocery stores

**⚠ CAUTION**

DO NOT use muriatic acid for the cleaning of any parts. Muriatic acid, even when strongly diluted, can harm chrome plating, and may leave a residue that is harmful to O-ring seals and other parts.

**⚠ CAUTION**

Aerosol spray silicone should be avoided because (1) common aerosol propellants may attack plastic and rubber parts, and (2) because only a slight amount of silicone remains after the solvent evaporates, and provides no lasting benefit.

**⚠ CAUTION**

Silicone rubber requires no lubrication or preservative treatment. DO NOT apply silicone grease or spray to silicone rubber parts. Doing so will cause a chemical breakdown and premature deterioration of the material.

## DISASSEMBLY PROCEDURES

### NOTE

Before performing any disassembly, refer to Table 4, which references all mandatory replacement parts. These parts must be replaced with new, and must not be reused under any circumstances - regardless of the age of the regulator or how much use it has received since it was last serviced.

### CAUTION

To prevent damage to critical sealing surfaces, use only a plastic or brass O-ring removal tool (P/N 9440-22) when removing O-rings. Once an O-ring sealing surface has been damaged, the part must be replaced with new in order to prevent the possibility of leakage. DO NOT use a dental pick, or any other type of steel instrument.

1. While holding the retaining nut(2) secure at the second stage inlet fitting with an  $\frac{1}{16}$ " open end wrench, apply a second  $\frac{1}{16}$ " open-end wrench to the female fitting of the LP hose(16). Turn the fitting counter-clockwise to loosen and remove the hose from the second stage. Remove the O-rings from the hose and discard. Set the hose aside.
2. While holding the case(11) secure, remove the exhaust tee(16) by firmly pulling one side off and then the other.

### CAUTION

Do not use a tool to remove the exhaust tee. Doing so may cause serious damage to the seating flange, requiring replacement of the case.

3. Remove the exhaust valve diaphragm(12) from the case. Discard, and do not reuse.
4. Carefully snip the mouthpiece clip(15) and remove the mouthpiece(14) from the case(11). Inspect the mouthpiece to ensure it is free of any tears or cuts that may cause leakage of water into the second stage or other discomfort. Discard the mouthpiece or set it aside to be reused, depending on its condition.
5. To remove the case cover, mate the two pins of the case cover tool (P/N AT31) into the case cover with the opening aligned over the APEKS logo at one o'clock (see Fig. 1). While holding the tool pressed inward and securely engaged, turn the case cover counter-clockwise to loosen and remove.

### NOTE

NOTE: The TX100 requires a different case cover tool (P/N AT42) which can be mated into any two opposing slots.

6. The purge button can be removed, if cleaning or replacement is necessary, by flexing two opposing arms inward while holding the case cover between thumb and forefinger with its underside facing up (see Fig. 2). Separate the spring from the button, and replace the decal with new if needed.



**Figure 1**

*Case Cover Tool Alignment*

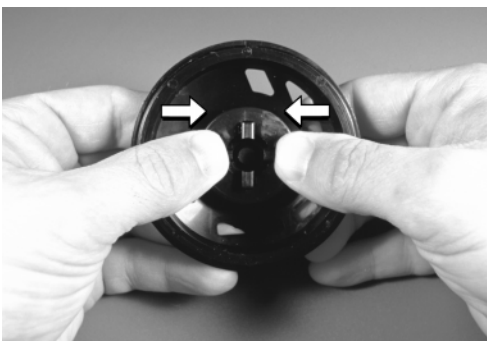

**Figure 2**

*Removing Purge Button*

7. Lift out the diaphragm cover(9) and diaphragm(10) from the case, and closely inspect the diaphragm to ensure that it is perfectly round and free of any tears, deterioration, or other damage. If deterioration or damage is found, discard the diaphragm and do not reuse.
8. Turn the adjusting screw(25) completely out counter-clockwise until it stops, either by hand for models TX100 and TX50, or with the use of a 5mm hex key for models TX40 and T20 (see Fig. 3). This will hold the retaining pin(18) in place when the valve module is removed from the case.
9. Apply an 11/16" open end or box wrench to the retaining nut(2), and turn the nut counter-clockwise to loosen and remove from the threaded inlet portion of the spindle. Remove either the heat exchanger or spacer (item #3), which will slide off freely after the retaining nut has been removed.

**NOTE** More recent models may contain a threaded heat exchanger or spacer which do not require a separate retaining nut.

10. While holding the case secure and the lever(22) completely depressed, press against the threaded inlet as needed until the valve spindle can be grasped from the opposite side. Firmly grasp the end of the spindle or the external adjusting screw, and pull the entire valve assembly straight out of the case (see Fig. 4). Remove and discard the O-ring(23) from inside the case if it did not fall off the end of the spindle.

**CAUTION**

Do not attempt to remove the valve module assembly from the case without first holding the lever depressed. Doing so may cause serious damage to the case, lever, or shuttle valve, which will require their replacement.

11. Remove the venturi lever(17) from the case, if it remained inside when the valve assembly was removed, or hold the lever depressed to remove it from the spindle (see Fig. 5). Remove and discard the O-ring(13).
12. While holding the valve spindle secure and horizontal with the lever facing down, turn the adjusting screw slightly clockwise to allow the retaining pin(18) to fall out. Set the pin aside.

**NOTE** If the retaining pin does not easily fall out of the valve spindle after the adjusting screw has been turned slightly clockwise, it may be necessary to press it out, using the pin of the Seat Extraction Tool (P/N 1094-36).

13. Continue to hold the valve spindle secure, and turn the adjusting screw counter-clockwise until it has disengaged from the threads of the spindle. Remove and discard the O-ring(25).
14. While holding the valve spindle vertical with the inlet end facing up, lift the lever up to allow the shuttle valve(30) and counter balance cylinder(27) to fall out of the valve spindle (see Fig. 6). Separate these items from the spring(28) between them.



**Figure 3**

*Removing Adjusting Screw (TX40/ T20)*

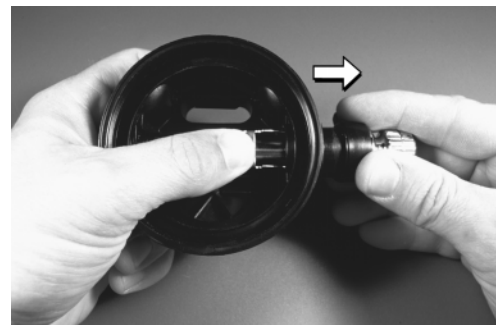

**Figure 4**

*Removing Valve Module*

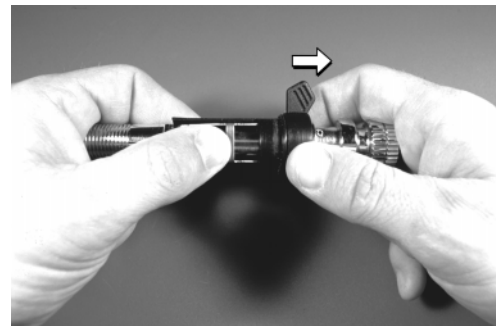

**Figure 5**

*Removing Venturi Lever*



**Figure 6**

*Removing Yoke Connector*



15. Closely examine the spring with a magnifier to ensure it is not damaged (bent) or corroded. If any signs of damage or corrosion are found, discard the spring and do not reuse.
16. Using a fingernail, remove the rubber seat(31) and the small O-ring(29) from the shuttle valve. Discard both the seat and O-ring and do not reuse.

**CAUTION**

Do not use a metallic instrument or any other tool to remove the seat or the O-ring. Doing so may damage the shuttle valve, which could result in a leak if the damage is undetected and the shuttle valve is not replaced.

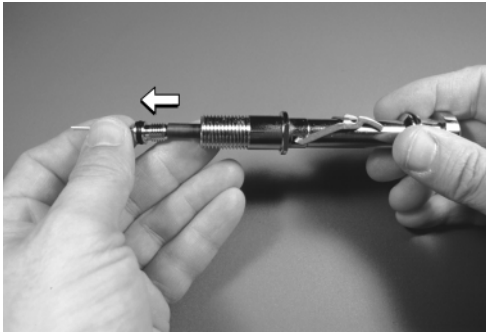

**Figure 7**  
*Removing Seat Crown*

17. Closely inspect the condition of the shuttle valve to check for any signs of damage, especially at the “ears,” which engage with the lever. Set the shuttle valve aside if it is found to be in reusable condition, or discard and replace it with new if damage is present.
18. While holding the spindle secure, apply a 5mm hex key to the head of the seat crown(19) inside the threaded inlet. Turn the crown counterclockwise to disengage its threads.

**NOTE**

Because the seat crown is O-ring sealed, it will not freely exit the valve spindle after it has been unthreaded. The following step must be performed correctly in order to remove the crown without damaging its delicate sealing surface.

19. When the seat crown has been unthreaded from the valve spindle, carefully insert the pin of the Seat Extraction Tool through the opposite end of the valve spindle and through the opening in the center of the crown. Gently pull the crown out, and remove and discard the O-ring(20). (See Fig. 7.)
20. Closely examine the seat crown with the use of magnifier, checking for any scoring, nicks, or other damage to the polished sealing surface. If damage is found, discard the crown, and do not attempt to reuse. If it is in reusable condition, set it aside on a soft surface to prevent damage to the sealing surface.
21. Remove and discard the O-ring(23) from the valve spindle.

**NOTE**

Do not attempt to remove the lever from the valve spindle unless it is suspected to be damaged. If removal is necessary, the lever should automatically be discarded and replaced with new, due to the damage that may result in the process of removing it.

22. To remove the lever, hold one arm pressed against the side of the valve spindle while pulling the other arm out of the opposite side. When it has disengaged from the valve spindle, pull the other arm out. Discard the lever and do not reuse.

*This concludes the disassembly procedures.*

## CLEANING & INSPECTION PROCEDURES

1. All parts should be cleaned first in a warm (not over 120°F) mild soap and water solution. Use a soft nylon bristle brush to help remove any excess or loose contamination. After an initial warm water and soap cleaning all parts should be thoroughly rinsed in clean fresh water and dried with filtered low pressure (30 psig) air. After an initial cleaning in warm soap and water solution, metal parts should be cleaned in an ultrasonic cleaner using the appropriate ultrasonic cleaning solution (see Lubricant and Cleaner Table 2).

**NOTE** Be sure all O-rings and other rubber or plastic parts are removed before cleaning in an ultrasonic cleaner or chemical bath. Cleaning solutions may damage these components.

2. If an ultrasonic cleaner is not available, metal parts can be cleaned by soaking the metal parts in a chemical bath solution of Chromesafe (see Lubricant and Cleaner Table 2) and agitating gently for 3-4 minutes. Cleaning of metal parts can also be done by soaking in a mild acetic solution (distilled white household vinegar) for 10-15 minutes.

**NOTE** Cleaning times in excess of those recommended may damage plated parts. Never clean parts for longer than specified by the manufacturer of the solution used. After completion of cleaning in any solution, thoroughly rinse parts with clean fresh water and blow dry with low pressure (30 psig) air. Only brass, plated brass, and stainless steel parts should be immersed in chemical cleaning solutions.

**WARNING**

Use hand and eye protection when handling chemical cleaning solutions.

3. After cleaning, all parts should be thoroughly rinsed in fresh water and dried with filtered low pressure (30 psig) air.

**NOTE** Before performing any reassembly, it is important to inspect all parts, both new and those that are being reused, to ensure that each part is clean and free of any contamination, corrosion, or blemish.

4. All O-rings should be replaced at every servicing. New O-rings should be inspected for contamination and/or imperfections, and lightly dressed with a thin film of approved lubricant prior to installation. (See Lubricant and Cleaner Table 2.)

**CAUTION**

Do not use any petroleum based lubricants or products, or any aerosol silicone sprays on any part of Sea Quest/ Apeks regulators. The petroleum base or propellant gas may attack or weaken plastic or rubber parts. Refer to Table 2 for a list of approved lubricants.

5. In addition to the O-rings, the following parts should be routinely replaced at the time of servicing:

- Exhaust Valve Diaphragm (12)
- Rubber Seating (31)
- Mouthpiece Clip (15)

All O-rings and the above mentioned routine replacement parts are included in the Overhaul Service Kit (P/N APO219).

6. The following parts should be closely inspected for the damage listed below. Close inspection is best accomplished by using strong magnification under bright lighting.
  - **Lever (22)** Compare with new to inspect for bending or distortion.
  - **Valve Spring (28)** Inspect for signs of permanent corrosion, including pitting or cracks in the surface of the metal.
  - **Seat Crown (19)** Inspect the cone area for nicks, scratches, pitting, or any defects in the plating. Pay particular attention to the sealing edge of the cone.
  - **Shuttle Valve (30)** Inspect for scratches or other damage, particularly at the groove which holds the small O-ring, and around the "ears."
  - **Demand diaphragm (10)** Inspect for tears or pinholes. To detect pinholes, hold diaphragm up to a light source as you gently stretch the diaphragm. Inspect the round plastic diaphragm plate for any evidence of damage.
  - **Mouthpiece (14)** Inspect for cracking or tears or any excessive wear especially around the bite tabs.
  - **Case (11)** Inspect for any indication of cracks or thread damage. Closely examine the seating ledge which indexes with the poppet housing, to ensure it is free of any distortion or other damage.
7. If any of the listed parts show any damage, they must be replaced with new.
8. Check all metal parts for excessive wear or corrosion. Check all metal sealing surfaces which make contact with O-rings for any signs of contamination and/or imperfections that may cause leakage past the O-ring seal. Examine all chrome plated surfaces for any evidence of peeling or flaking of the chrome plating. Inspect all threads for galling, cross threading, or damage to the chrome plating. If any parts show damage or excessive wear, they must be replaced with new.

## REASSEMBLY PROCEDURES

**NOTE** Before performing any reassembly, it is important to inspect all parts, both new and those that are being reused, to ensure that every part and component is perfectly clean and free of any dust, corrosion, or blemishes. Before dressing each O-ring with Christo-Lube®, check to ensure it is clean, supple, and free of any blemish.

**WARNING**

Use only genuine Apeks parts, subassemblies, and components when ever assembling any Apeks product. DO NOT attempt to substitute an Apeks part with another manufacturer's, regardless of any similarity in shape, size, or appearance. Doing so may render the product unsafe, and could result in serious injury or death.

1. Install the O-ring(26) into the groove on the small end of the adjusting screw(25), and set the adjusting screw aside.
2. Install a new rubber seat(31) into the shuttle valve(30) by pressing the stem inward until the lip of the seat is seated evenly on all sides. Next, install the small O-ring(29) onto the opposite end of the shuttle valve.
3. Fit one end of the spring(28) over the open end of the counterbalance cylinder(27), and then insert the stem of the shuttle valve into the opposite end. While holding these items together, press the counterbalance cylinder and shuttle valve together, compressing the spring slightly, so that the counterbalance cylinder seals over the small O-ring on the stem of the shuttle valve.
4. Install the O-ring(23) onto the grooved flange of the valve spindle(21).
5. If the lever(22) was removed, lay the valve spindle lengthwise with the threaded inlet facing to the right (3 o'clock) and the outlet port facing toward 6 o'clock (see Fig. 8). While holding the lever standing up, perpendicular to the spindle, insert one arm into one of the square holes that are located near the flange, and then hold it securely in place while rotating the lever slightly over the spindle until the other arm fits into the opposite square hole. Closely examine the shape and position of the lever to ensure that the arms have not become stretched or bent during installation.
6. While holding the lever in place, stand the valve spindle vertically with the male threaded inlet end facing down, and positioned so that the lever faces to the right. While holding the shuttle valve and spring by the counterbalance cylinder, align the shuttle valve above the spindle so that the two retaining ears which engage the arms of the lever are facing directly to the left; opposite of the lever (see Fig. 9).
7. Lift the lever completely up and hold it against the valve spindle. Then, drop the shuttle valve and counterbalance cylinder straight down inside the barrel of the spindle while being careful to avoid disturbing the alignment of the shuttle valve (see Fig. 10). Slowly lower the



**Figure 8**  
*Installing Lever Arm*



**Figure 9**  
*Installing Shuttle Valve - Step 1*

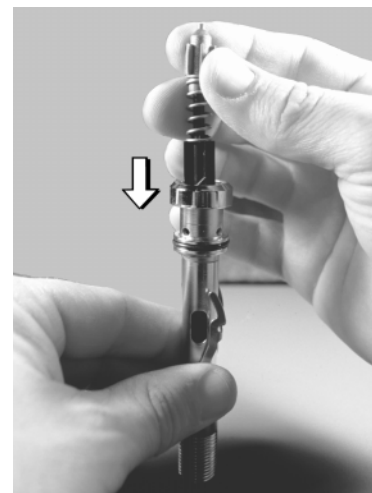

**Figure 10**  
*Installing Shuttle Valve - Step 2*



**Figure 11**  
*Installing Shuttle Valve - Step 3*

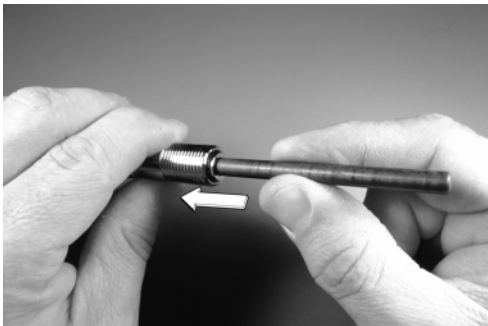

**Figure 12**  
*Installing Seat Crown*

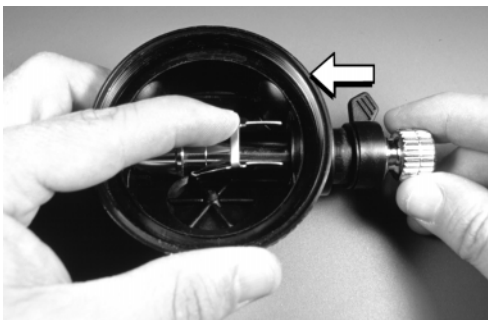

**Figure 13**  
*Installing Valve Module*



**Figure 14**  
*Correct Index of Valve Spindle w/ Case*

lever until the shuttle valve drops slightly, while viewing its position through the outlet port of the spindle (see Fig. 11). Then, raise the lever halfway up until it is perpendicular to the valve spindle.

8. Being careful to avoid disturbing the engagement of the lever with the shuttle valve, lay the valve spindle horizontal with the lever facing up. While holding the spindle secure, mate the adjusting screw into the open end of the spindle, and hold it pressed inward while turning it clockwise until the threads are engaged.

**NOTE** Watch to ensure that the lever rises initially as the adjusting screw is installed into the valve spindle. If the lever does not rise, the arms are not properly engaged with the shuttle valve. Disassemble and repeat steps 6-8 before proceeding.

9. Insert the retaining pin(18) into the valve spindle, near the grooved flange. Hold it centered in place, and then turn the adjusting screw completely out counter-clockwise until it stops. This will hold the pin securely in place to prevent it from falling out while installing the valve module into the case.
10. Install the O-ring(13) onto the venturi lever(17).
11. While holding the valve lever depressed against the spindle, fit the venturi lever over the threaded inlet with the plastic lever facing toward the adjusting screw. Gently pass it over the spindle until it is seated against the opposite end, and then slowly release the valve lever to prevent it from springing up.

**CAUTION**

Be careful not to turn the external adjusting screw while installing the venturi lever onto the valve spindle. It is very important to keep the screw turned completely out counter-clockwise, in order to hold the retaining pin in place.

12. Install the O-ring(20) onto the seat crown(19), and carefully insert the threaded end of the crown into the inlet end of the valve spindle. Gently press it in further with the blunt end of the seat extraction tool (P/N 1094-36) until it stops (see Fig. 12).
13. Apply a 5mm hex key to the head of the seat crown, and turn the crown clockwise to engage the threads. Continue turning the crown clockwise only until the lever begins to drop slightly.
14. Orient the case with the exhaust valve facing down, at 6 o'clock. While holding the lever depressed, guide the inlet end of the valve spindle through the opening in the right side of the case and into the opening on the opposite side, until the lever can stand up (see Fig. 13). Check to ensure that the venturi lever is correctly aligned to fit in its groove outside the case, and the valve lever is facing straight up. Carefully guide the valve spindle completely to the left until the flange is seated flush against the inside of the case, and the arms of the lever are positioned inside the retaining tabs on either side (see Fig. 14).
15. While holding the valve module securely seated inside the case, fit the O-ring(4) down over the threaded inlet of the valve spindle.

16. Fit either the spacer or the large diameter end of the heat exchanger (item #3) over the threaded inlet of the spindle, and then thread the retaining nut(2) clockwise by hand onto the spindle until it is finger snug. Check again to ensure that the valve module is held secure inside the case with the flange and lever arms fitted inside the retaining tabs. Then, apply a torque wrench with  $1\frac{1}{16}$ " socket to tighten the retaining nut (or the hex fitting of a newer revision spacer/ heat exchanger) to a torque measurement of 50 inch-lbs.
17. Check the height of the lever to ensure that it stands perfectly level with the rim of the case, with a slight freeplay that does not exceed 1.0 mm. If necessary, apply a 5mm hex key to adjust the seat crown as needed to raise or lower the lever until it is level with the case rim.
18. Install the exhaust valve diaphragm(12) into the box bottom by gently pulling the stem through the hole in the center of the support spokes, until the barb has passed through and is securely seated against the opposite side. Gently turn the diaphragm outside the case to position the rib perfectly horizontal. Then, carefully snip off the excess material of the stem inside the case with a small pair of scissors.
19. Install the exhaust tee(16) onto the case by fitting it over one upper corner of the seating flange and then stretching it over the other. Firmly press the lower portion of the tee onto the flange until it is completely seated.
20. Install the diaphragm(10) into the case with its raised center facing up, and check to ensure it is evenly seated onto the shoulder at the base of the threads.
21. Place the diaphragm cover(9) over the diaphragm with the support cone facing up, and press it down to ensure that it seated evenly on all sides.
22. If the purge button(6) was disassembled from the case cover(8), fit the spring(7) over the four tabs of the purge button with the smaller diameter end facing down. Then, position the purge button inside the front of the case cover so that the logos on the decal and the cover are correctly aligned with each other. Press the purge button into place so that all four mating tabs are seated inside of the case cover.
23. Mate the case cover onto the case, and turn it clockwise by hand until snug. Apply the case cover tool (P/N AT31 or AT42) to tighten it further until the purge button logo is properly aligned.
24. Install the mouthpiece(14) onto the box bottom, and lightly fasten a clamp(15) onto the groove of the mouthpiece. Turn the clamp so that the locking tab is facing toward the inlet side of the box bottom, and pull the clamp sufficiently snug. Snip the extra length with a small pair of scissors or wire cutters.

***This concludes the reassembly of the second stage. Refer directly to the following section, titled Final Adjustment & Testing.***

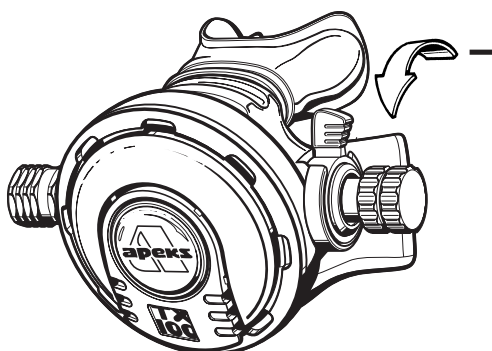

**Figure 15**  
Venturi Lever "MIN" Setting

**FINAL ADJUSTMENT AND TESTING PROCEDURES**

**CAUTION**

Prior to adjusting and testing the Apeks second stage regulator, the accompanying first stage must be correctly serviced, adjusted to a stable intermediate pressure of 140 psi, and fully tested. Refer to the corresponding first stage service procedures before attempting to perform the adjustment and testing of the second stage.

1. Thread the male fitting of the IP hose into the preferred low pressure port of the first stage, and apply a torque wrench with 1<sup>1</sup>/<sub>16</sub>" crow-foot to tighten to 40 inch-pounds (±2).
2. Turn the second stage adjustment screw completely out counter-clockwise, and set the venturi lever to the "MIN" position (see Fig. X).
3. Connect the first stage to a filtered air source of 3,000 psi.
4. Turn the second stage adjustment screw exactly one full turn (360°) clockwise.
5. Slowly open the air supply valve to fully pressurize the regulator.
  - a. If airflow can immediately be heard when the regulator is pressurized, depressurize and purge the system. Disconnect the IP hose and remove the case cover, diaphragm cover, and diaphragm to re-check the height of the lever. The lever should be set at a height level with the rim of the case, with approximately 1.0 mm freeplay (see Fig. 16). If the lever is set too low or too high, apply a 5mm hex key through the inlet to adjust the crown seat – either counter-clockwise to raise or clockwise to lower the lever. When the lever is set correctly, re-install the diaphragm, diaphragm cover, and case cover, and connect the IP hose to the second stage.
6. When no airflow can be heard after the regulator has been pressurized, slowly depress the purge button to verify whether a strong airflow can be initiated when the button has traveled no more than 2mm.

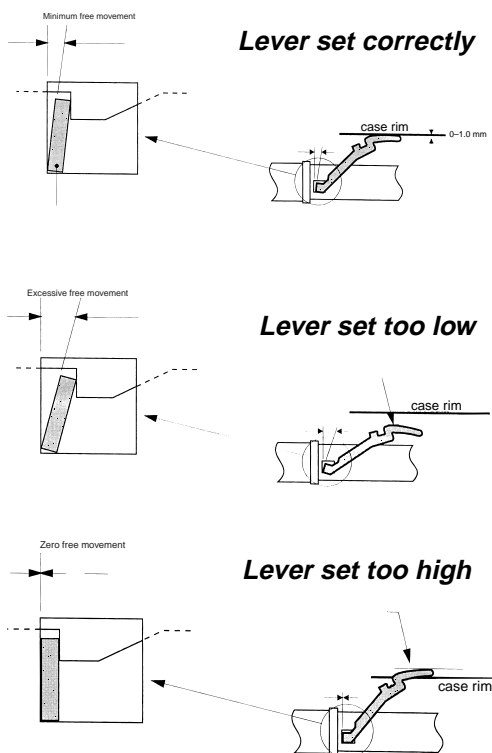

**Figure 16**  
Relationship between seat crown and lever height adjustment

**NOTE** If a strong purge cannot be initiated by depressing the purge button a maximum distance of 2mm, it will be necessary to adjust the seat crown slightly counter-clockwise. Excessive travel of the purge button indicates that the lever is set too low.

7. Depress the purge button sharply several times to ensure that leakage or freeflow does not occur.

**NOTE** If a slight leak occurs after sharply purging the second stage, it will be necessary to adjust the seat crown slightly clockwise, being careful to adjust only as far as needed to create a seal between the seat crown and rubber seating, without raising the lever too high.

8. Move the venturi lever to the "MAX" position and depress the purge button sharply. This should initiate a strong, continuous freeflow that can be eliminated by turning the venturi lever back to the "MIN" position.

9. To test the setting of the seat crown, turn the second stage adjustment screw completely out counter-clockwise to initiate a slight flow of air, and then slowly turn it back in clockwise to verify that the airflow has stopped completely before it has been turned 1 full turn. If more than 1 turn is required to shut off the airflow, it will be necessary to readjust the crown as described in step 5.
10. When all adjustments have been satisfactorily performed, apply a torque wrench with  $1/16$ " crow-foot to tighten the IP hose fitting to a torque measurement of 40 inch-lbs ( $\pm 3$ ).

### EXTERNAL LEAK TEST

1. After disconnecting the regulator from the flow bench, connect to a scuba cylinder filled to approximately 3,000 psi. Open the cylinder valve to repressurize the regulator, and submerge the entire system in a test tank of clean water.
2. Observe any bubbles arising from the submerged regulator over a one minute period. The recommended time is necessary due to slower bubble formation that occurs in smaller leaks. Bubbles indicate a leak, which requires that the system must be disassembled at the source to check sealing surfaces, assembly sequence and component positioning in order to correct the problem(s).

#### NOTE

Bubble streams will indicate the source of the leak. Before disassembling to correct any leaks, rinse the entire regulator thoroughly with fresh water and blow out all residual moisture with filtered, low-pressure (50 psi) air. Disassemble and remedy the problem, referring to Table 1 - [Troubleshooting](#).

### SUBJECTIVE BREATHING TEST

1. While the regulator is connected to a cylinder containing 3,000 psi and pressurized, turn the second stage adjustment knob completely out counterclockwise to the full positive position, and verify that a slight leak of airflow is present.
2. Slowly turn the adjustment knob in clockwise to verify that the airflow stops between  $1/2$ -1 turn.
3. Turn the adjustment knob completely in clockwise, and depress the second stage purge to ensure that an adequate volume of air needed to clear the second stage flows through the mouthpiece..
4. Turn the adjustment knob back to  $1/2$ -1 turn negative, and breathe from the second stage. A properly serviced and adjusted regulator should deliver air upon deep inhalation without excessive inhalation effort, freeflow, or "fluttering" of the second-stage diaphragm. When exhaling, there should be no fluttering or sticking of the exhalation valve. If any of these problems occur, refer to Table 3 - [Troubleshooting](#).

*This concludes the annual service procedures for  
Apeks Second Stage Regulators.*



**TABLE 3 – APEKS SECOND STAGE TROUBLESHOOTING**

SYMPTOM	CAUSE	ACTION REQUIRED
Leakage or freeflow from second stage	<ol style="list-style-type: none"> <li>1. High first-stage intermediate pressure. (should be 140 ±5 psi)</li> <li>2. Rubber seating(31) damaged or worn.</li> <li>3. Seat crown(19) incorrectly adjusted, lever(22) set too high.</li> <li>4. Seat crown(19) sealing surface damaged.</li> <li>5. Valve spring(28) damaged.</li> </ol>	<ol style="list-style-type: none"> <li>1. Refer to first-stage Troubleshooting Guide.</li> <li>2. Replace rubber seating</li> <li>3. Reset crown and perform Final Tuning &amp; Testing procedures.</li> <li>4. Replace seat crown.</li> <li>5. Replace poppet spring.</li> </ol>
Low purge or excessive work of breathing (full cylinder)	<ol style="list-style-type: none"> <li>1. Low intermediate pressure. (should be 140 ±5 psi)</li> <li>2. Lever(22) not properly engaged with shuttle valve(30).</li> <li>3. Seat crown(19) incorrectly adjusted, lever(22) set too low.</li> <li>4. Intermediate pressure hose clogged or obstructed.</li> </ol>	<ol style="list-style-type: none"> <li>1. Refer to first-stage Troubleshooting Guide.</li> <li>2. Disassemble and inspect condition of shuttle valve and lever.</li> <li>3. Reset crown and perform Final Tuning &amp; Testing procedures.</li> <li>4. Clean or replace hose.</li> </ol>
External air leakage	<ol style="list-style-type: none"> <li>1. Intermediate pressure hose loose. (Immersion Test)</li> <li>2. Seat crown O-ring(20) damaged.</li> <li>3. Case(11) damaged.</li> </ol>	<ol style="list-style-type: none"> <li>1. Tighten to 40 inch-lbs at female second-stage fitting.</li> <li>2. Disassemble and replace O-ring.</li> <li>3. Disassemble and replace case.</li> </ol>
Water entering second-stage	<ol style="list-style-type: none"> <li>1. Hole in mouthpiece(14).</li> <li>2. Demand diaphragm(10) damaged.</li> <li>3. Exhaust valve diaphragm(12) damaged.</li> <li>4. Venture lever O-ring(13) dirty, damaged, or worn.</li> <li>5. Case(11) damaged. (Check exhaust valve sealing surface.)</li> <li>6. Valve spindle O-ring(4) damaged.</li> </ol>	<ol style="list-style-type: none"> <li>1. Replace mouthpiece.</li> <li>2. Replace demand diaphragm.</li> <li>3. Replace exhaust valve diaphragm.</li> <li>4. Disassemble and replace O-ring.</li> <li>5. Disassemble and replace case.</li> <li>6. Disassemble and replace O-ring.</li> </ol>

**⚠ CAUTION**

Recommended treatments which require disassembly of the regulator must be performed during a complete overhaul, according to the prescribed procedures for scheduled, annual service. Do not attempt to perform partial service. For assistance with a problem not described here, contact a Sea Quest Technical Advisor.

**REGULATOR REPAIR AND REPLACEMENT PARTS**  
**APEKS SECOND STAGES**

Item	Description	Part #	Item	Description	Part #
1	Deflector	AP2037	14	Comfo-Bite Mouthpiece	109438
2	Nut - TX100	AP2031/S	<b>15</b>	<b>Mouthpiece Clip</b>	<b>104913</b>
	Nut - TX50/40, T20	AP2031	16	Exhaust Tee	AP2040
3	Heat Exchanger - TX100	AP5013/S	17	Venturi Lever - TX100	AP5339
	Heat Exchanger - TX50/40	AP5013		Venturi Lever - TX50/40, T20	AP2039
	Spacer - T20	AP5003	18	Spring Pin	AP1151
	Heat Exch., Threaded - TX50/40	*AP5002	19	Seat Crown	AP2033
	Heat Exch., Threaded - TX100	*AP5013	<b>20</b>	<b>O-ring</b>	<b>AP1154</b>
	Spacer, Threaded - T20	*AP5003	21	Valve Spindle - TX100	AP2028/S
<b>4</b>	<b>O-ring</b>	<b>AP1267</b>		Valve Spindle - TX50/40, T20	AP2028
5	Decal - TX100	AP5015	22	Lever	AP2035
	Decal - TX50	AP5004/1	<b>23</b>	<b>O-ring</b>	<b>AP1267</b>
	Decal - TX40	AP5004/2	24	Plug - TX100/50/40	AP2030
	Decal - T20	AP5004/3	25	Adjusting Screw - TX100	AP2029/2S
6	Purge Button	AP2053		Adjusting Screw - TX50	AP2029
7	Spring	AP2020		Adjusting Screw - TX40/T20	AP2029/1
8	Case Cover - TX100	AP5326	<b>26</b>	<b>O-ring</b>	<b>AP1409</b>
	Case Cover - TX50/40, T20	AP2026	27	Counter Balance Cylinder	AP2038
9	Diaphragm Cover	AP2025	28	Valve Spring	AP2021
10	Diaphragm	AP2023	<b>29</b>	<b>O-ring</b>	<b>AP2041</b>
11	Case	AP5001	30	Shuttle Valve	AP2036
<b>12</b>	<b>Exhaust Valve Diaphragm</b>	<b>AP1429</b>	<b>31</b>	<b>Rubber Seating</b>	<b>AP2034</b>
<b>13</b>	<b>O-ring</b>	<b>AP1438</b>	n/s	Overhaul Service Kit	AP0219

Items in bold are included in the Overhaul Service Kit

# Apeks Second Stages Schematic

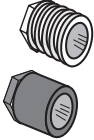
 \* NOTE: Apeks has recently introduced a new heat exchanger and spacer which feature a threaded fitting, and do not require a hex nut (item #2).

