



Yuasa Battery Sales (U.K) Limited, Hawksworth Industrial Estate, Swindon, Wiltshire SN2 1EG  
Telephone: Swindon (01793) 645700 Fax: (01793) 645701 e-mail: [enquiries@yuasa-sales.co.uk](mailto:enquiries@yuasa-sales.co.uk) Website: [www.yuasa-battery.co.uk](http://www.yuasa-battery.co.uk)

Yuasa Battery (Europe) GMBH, Wanheimer Str. 47, D-40472 Düsseldorf, Germany  
Telefon: 0049 211 417900 Fax: 0049 211 4179011

Issue Date 01.12.99



---

# YUASA

---



**NP**  
**VALVE REGULATED  
LEAD ACID BATTERY**

---

# MANUAL



## INTRODUCTION

---

Yuasa began development of the NP series of valve regulated lead acid batteries in 1958. Today's NP battery is the culmination of over 75 years of battery manufacturing experience.

The high energy density, advanced plate technology, sealed construction, efficient performance and long service life combine to make Yuasa NP batteries the most reliable and versatile valve regulated lead acid batteries available.

## ADVANCEMENTS

---

With the progress of modern technology and the specific development of application requirements, Yuasa has designed generic NP's to be application specific with the introduction of NPC, NPH and NPL product ranges.

**NPC** is specifically designed to suit the arduous requirements of cyclic applications allowing increased cycle life (at least double the cyclic life of conventional types).

**NPH** These high performance batteries are specifically designed for applications requiring high rate discharge and offer much improved power densities up to 50% more

watts per kilo than conventional NP models when operated at the 10 minute discharge rate.

**NPL** Offers up to double the float service life of the conventional NP type battery. Note, these models are available to BS6290pt4 (1997).

The generic types utilise identical physical designs and characteristics to the standard NP type in all aspects except their specific application advancement. This in many cases allows users to upgrade without major redesign.

## TECHNICAL FEATURES

---

- **Sealed Construction** ..... Yuasa's unique construction and sealing technique ensures that no electrolyte leakage should occur from the terminals or case of any NP battery. This feature provides for safe and effective operation of NP batteries in any orientation. Yuasa NP batteries are classified as "Non-Spillable" and meet all requirements of the International Air Transport Association. (I.A.T.A. Dangerous Goods Regulations), to allow transportation by air.
- **Electrolyte Suspension System** ..... All Yuasa NP batteries utilise an electrolyte suspension system consisting of a glass fibre separator material. This suspension system helps to achieve maximum service life, by fully retaining the electrolyte and preventing its escape from the separator material. No silica gels or other contaminants are used.
- **Gas Generation** ..... NP batteries incorporate a unique Yuasa design that effectively recombines over 99% of the gas generated during normal usage.
- **Low Maintenance Operation** ..... During the life of NP batteries, there is no need to check their specific gravity or add water etc. In fact, there are no provisions for such maintenance functions to be carried out.
- **Operation In Any Orientation** ..... The combination of sealed construction and Yuasa's electrolyte suspension system permits operation of NP batteries in any orientation (excluding continuous inverted use) without loss of capacity, electrolyte, or service life. The NP batteries made in our factory in Wales also conform to BS EN61056-1 (1993) and IEC 1056-1 (1991).
- **Low Pressure Venting System** ..... Yuasa NP batteries are equipped with a safe, low pressure venting system, which is designed to release excess gas and reseal automatically in the event of the internal gas pressure rising to an unacceptable level. This low pressure venting system, coupled with the significantly high recombination efficiency, make Yuasa NP batteries one of the safest valve regulated lead acid batteries available.
- **Heavy Duty Grids** ..... The heavy duty lead calcium alloy grids in NP batteries provide an extra margin of performance and service life in both float and cyclic applications, even in conditions of deep discharge.
- **Cyclic Service Life** ..... Depending upon the average depth of discharge, over 1,000 discharge/recharge cycles can be expected from NP batteries.
- **Float Service Life** ..... The expected service life of the standard model NP battery when used in stand-by applications is typically 5 years; however, experience has shown that their service life often exceeds 6 years, if the NP batteries are operated strictly within specification.

- **Low Self Discharge -Long Shelf Life .** At temperatures of between 20 & 25°c, the self discharge rate of NP batteries per month is approximately 3% of their rated capacity. This low self discharge rate permits storage for up to one year without any appreciable deterioration of battery performance.
- **Operating Temperature Range .....** Yuasa NP batteries can be used over a broad range of ambient temperatures, allowing considerable flexibility in system design and location.
- **High Recovery Capability .....** Yuasa NP batteries have excellent charge acceptance and recovery capability, even after very deep discharge.
- **Quality Assurance .....** Our U.K. manufacturing plant now has Quality Assurance Standard BS5750 Part 2 EN2900, ISO 9002 together with the M.O.D. Quality Assurance AQAP 4.

## APPLICATIONS

---

A list of some of the more common applications for standby or principal power is given below:

- |   |  |
|---|--|
| <ul style="list-style-type: none"> <li>● Alarm Systems</li> <li>● Cable Television</li> <li>● Communications Equipment</li> <li>● Computers</li> <li>● Control Equipment</li> <li>● Electronic Cash Registers</li> <li>● Electronic Test Equipment</li> <li>● Emergency Lighting Systems</li> <li>● Fire &amp; Security Systems</li> <li>● Geophysical Equipment</li> <li>● Marine Equipment</li> </ul> | <ul style="list-style-type: none"> <li>● Medical Equipment</li> <li>● Microprocessor Based Office machines</li> <li>● Portable Cine &amp; Video Lights</li> <li>● Power Tools</li> <li>● Solar Powered Systems</li> <li>● Telecommunication Systems</li> <li>● Television &amp; Video Recorders</li> <li>● Toys</li> <li>● Uninterruptible Power Supplies</li> <li>● Vending Machines</li> </ul> |
|---|--|

## YUASA NP BATTERY CONSTRUCTION

---

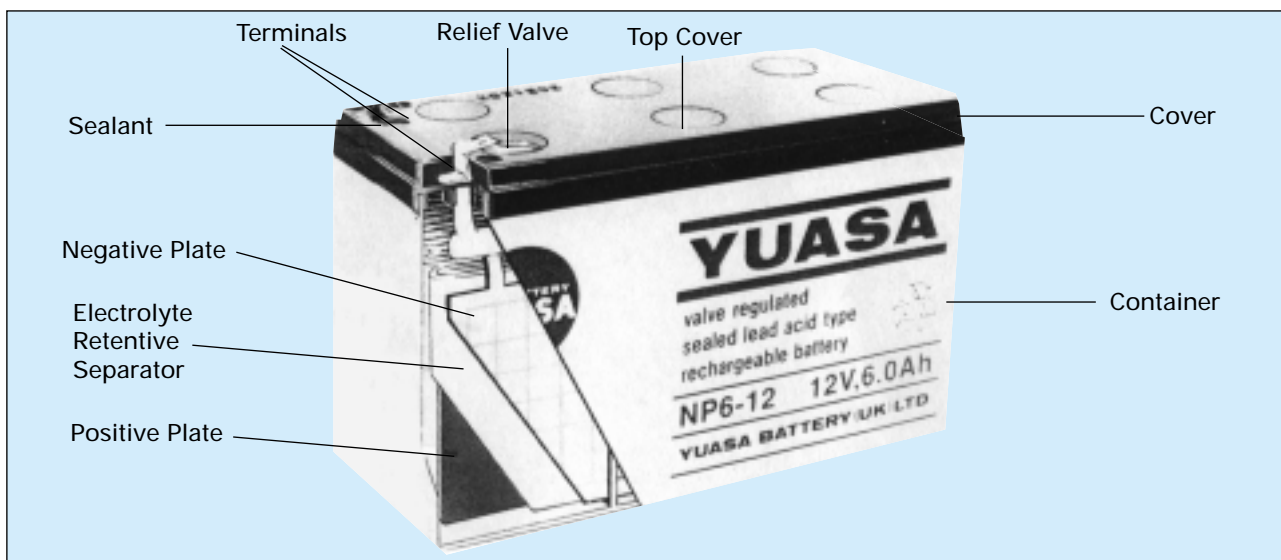

## GENERAL SPECIFICATIONS

Model	Nominal Voltage (V)	Nominal Capacity (Ah)		Dimensions					
		(20Hr.)	(10Hr.)	L(mm)	W(mm)	Height over Terminals (mm)	Weight Approx (Kg)	Layout	Terminals
NP4.2-4H	4	4.4	4.20	48	35.5	119	0.56	6	Flat
NP10-4	4	10.0	9.25	102	50	98	1.35	1	D
NP1-6	6	1.0	0.93	51	42.5	54.5	0.25	5	A
NP1.2-6	6	1.2	1.11	97	25	54.5	0.31	1	A
NP2.8-6	6	2.8	2.60	134	34	64	0.57	1	A
NP3-6	6	3.0	2.78	134	34	64	0.63	1	A
NP4-6	6	4.0	3.70	70	47	105.5	0.87	5	A
NP7.6	6	7.0	6.48	151	34	97.5	1.32	1	A
NP10-6	6	10.0	9.25	151	50	97.5	1.98	1	A&C
NP12-6	6	12.0	11.10	151	50	97.5	2.05	1	C
NPL130-6	6	130.0	120.25	350	166	174	23.00	5	K
NP0.8-12	12	0.8	0.74	96	25	61.5	0.35	9	I
NP1.2-12	12	1.2	1.11	97	48	54.5	0.58	3	A
NP2-12	12	2.0	1.85	150	20	89/85	0.70	10	B
NP2.1-12	12	2.1	1.90	178	34	64	0.82	1	A
NPH2-12FR	12	-	2.00	68	51	88	0.84	2	A
NP2.3-12	12	2.3	2.13	178	34	64	0.95	1	A
NP2.8-12	12	2.8	2.60	134	67	64	1.12	3	A
NP3.2-12	12	3.2	3.00	134	67	64	1.2	4	A
NPH3.2-12	12	-	3.20	134	67	64	1.40	3	A
NP4-12	12	4.0	3.70	90	70	106	1.75	1	A&C
NPH5-12	12	-	5.00	90	70	106	2.00	1	D
NP7-12	12	7.0	6.48	151	65	97.5	2.65	4	A&C
NP12-12	12	12.0	11.10	151	98	97.5	4.05	4	D
NP17-12	12	17.0	13.88	181	75	167	6.1	2	J&E
NPH16-12	12	-	16.00	181	76	167	6.20	2	E
NP24-12	12	24.0	22.20	166	175	125	9.0	2	J&E
NP38-12	12	38.0	35.15	197	165	170	14.2	2	J&F
NP65-12	12	65.0	60.13	350	166	174	23.0	2	K&G
NPL78-12	12	78.0	72.15	380	166	174	27.5	2	K&L
NPL100-12	12	100.0	92.00	407	172.5	240	39	1	M10 <small>bolt</small>

Table 2. LAYOUT

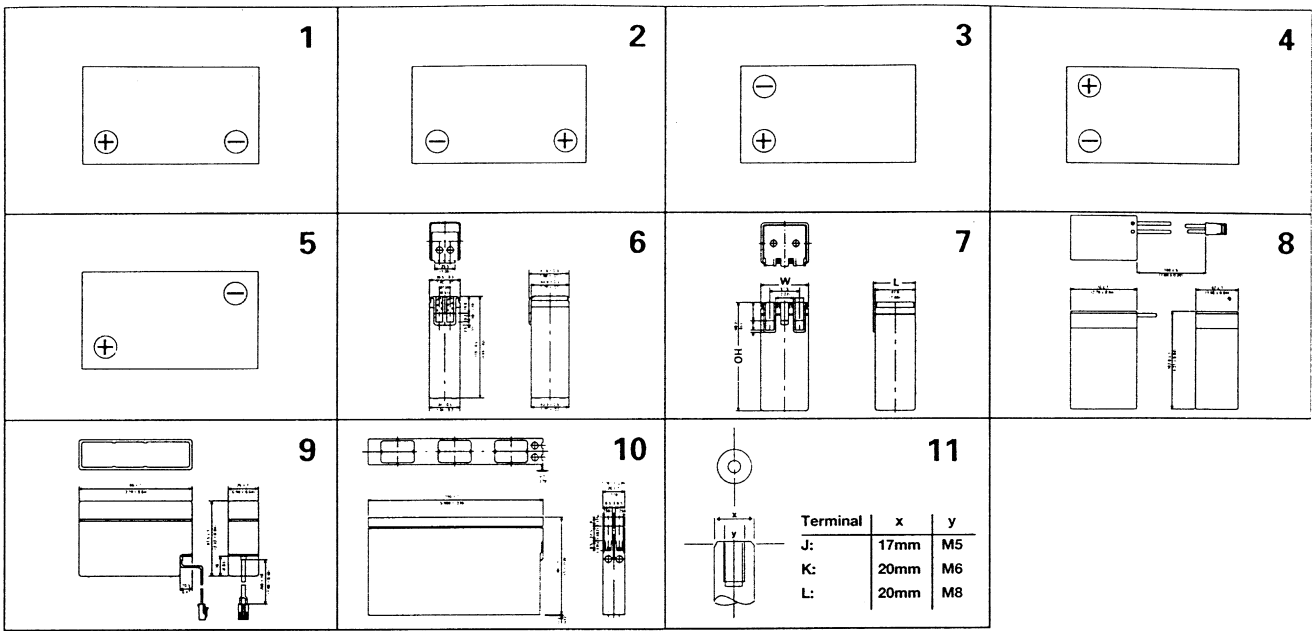
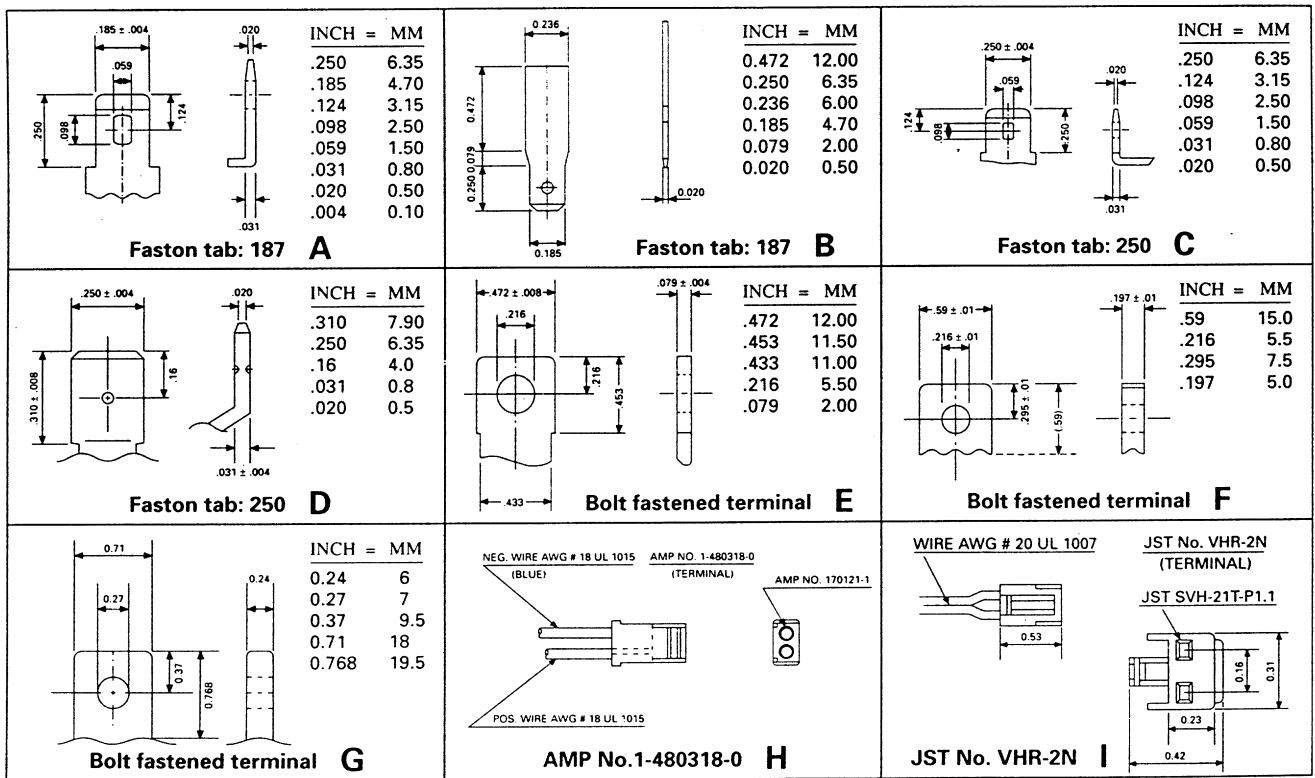

Table 3. TERMINALS



Terminal	Maximum Permissible Current (Amps)		
	Continuous	1Hr.	1 min.
Faston tab 187	16	24	48
Faston tab 250	25	38	75
Wire Lead 0.5mm <sup>2</sup>	7	20	30

## BATTERY CAPACITY SELECTION

Figure 2 below may be used to determine the minimum battery size, expressed in Ampere hours of capacity. To determine the required minimum battery capacity, plot the required discharge current, on the horizontal axis, against time. The point where the current and time lines intersect on or below the diagonal Ah curve shows the minimum capacity required for the application. In practice, if the intersection point of the time & current

does not fall exactly on a particular Ah curve, the next higher value Ah curve should be used to determine the minimum battery capacity/size. In addition, it is recommended that figure 32 (Cyclic Service Life) and Figure 33 (Float Service Life) and if appropriate, the constant power calculations in table 5, on page 7, should be consulted prior to final selection.

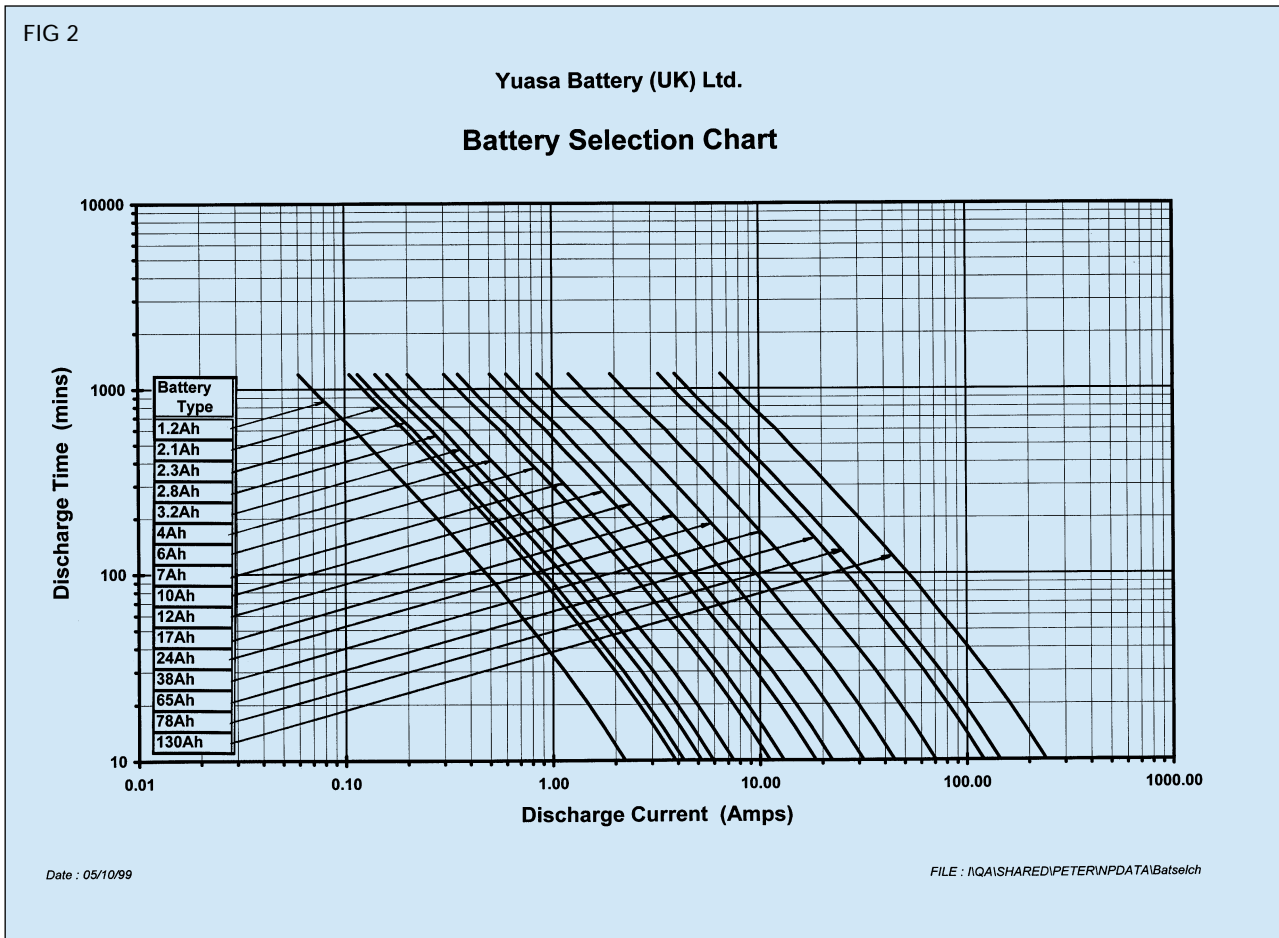

## DISCHARGE

### ■ Discharge Characteristics

The curves shown in Figure 3 and the discharge current rates shown in Table 4 illustrate the typical discharge characteristics of Yuasa NP batteries at an ambient temperature of 25°. The symbol "C" expresses the nominal capacity of the battery measured at a 20-Hour discharge rate. Please refer to General Specifications on page 3 to determine the nominal capacity rating of specific NP models. The standard industry practice to determine the nominal capacity of a valve regulated lead acid battery is to discharge the battery under test at its 20-Hour rate to a final voltage of 1.75 volts per cell.

Table 4 shows the different currents that can be drawn at various discharge capacity rates.

Table 6 shows that the rated nominal capacity of a battery is reduced when it is discharged at a value of current that exceeds its 20-Hour discharge rate. This should be taken into consideration when a battery is being selected for a particular application.



Figure 3. NP DISCHARGE CHARACTERISTIC CURVES AT 25°C (77°F)

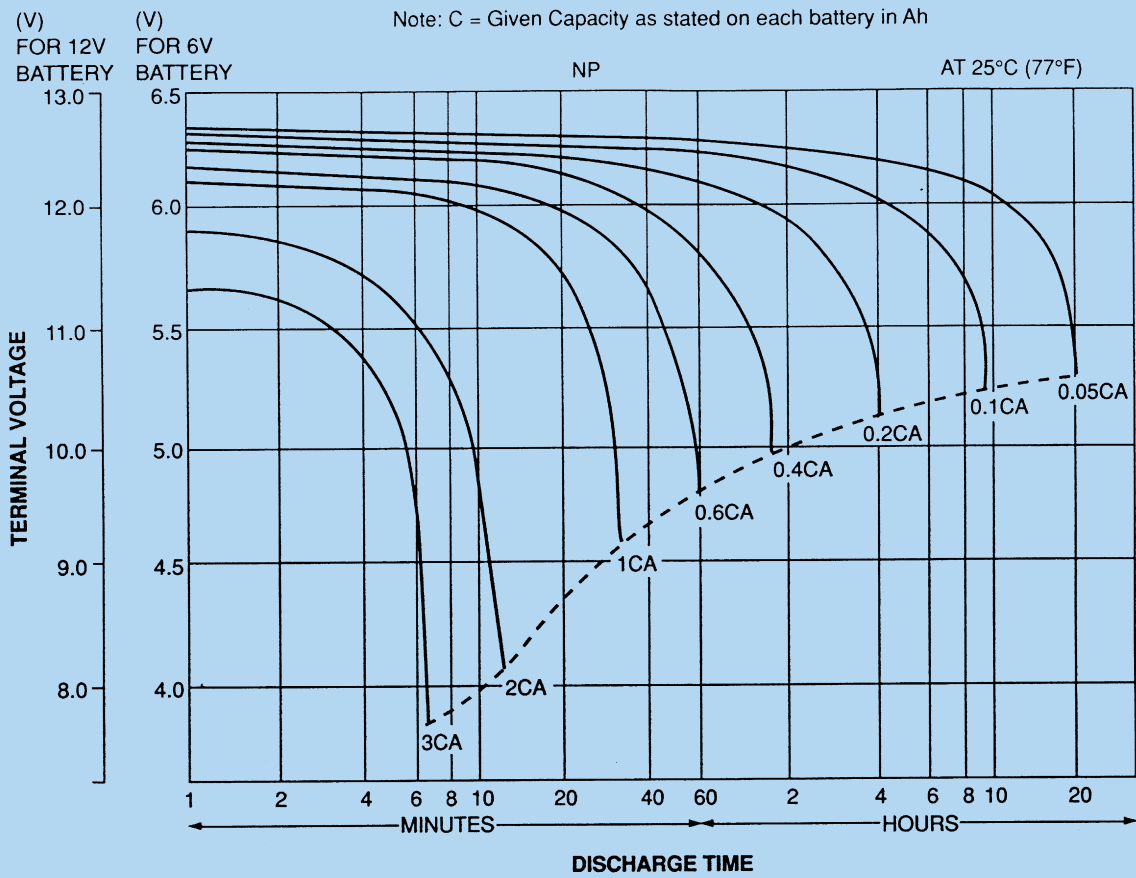

Table 4. DISCHARGE CURRENT AT STIPULATED DISCHARGE RATES

20 Hr. Capacity	Discharge Current							
	0.05C	0.1C	0.2C	0.4C	0.6C	1C	2C	3C
0.8 Ah	0.04 A	0.08 A	0.16A	0.32A	0.48 A	0.8A	1.6A	2.4 A
1.0	0.05	0.10	0.20	0.40	0.60	1.0	2.0	3.0
1.2	0.06	0.12	0.24	0.48	0.72	1.2	2.4	3.6
2.1	0.105	0.21	0.42	0.84	1.26	2.1	4.2	6.3
2.0	0.10	0.20	0.40	0.80	1.20	2.0	4.0	6.0
2.3	0.115	0.23	0.46	0.92	1.38	2.3	4.6	6.9
2.8	0.14	0.28	0.56	1.12	1.68	2.8	5.6	8.4
3.0	0.15	0.30	0.60	1.20	1.80	3.0	6.0	9.0
4.0	0.20	0.40	0.80	1.60	2.40	4.0	8.0	12.0
6.0	0.30	0.60	1.20	2.40	3.60	6.0	12.0	18.0
7.0	0.35	0.70	1.40	2.80	4.20	7.0	14.0	21.0
8.0	0.40	0.80	1.60	3.20	4.80	8.0	16.0	24.0
10.0	0.50	1.00	2.00	4.00	6.00	10.0	20.0	30.0
12.0	0.60	1.20	2.40	4.80	7.20	12.0	24.0	36.0
17.0	0.85	1.70	3.40	6.80	10.20	17.0	34.0	51.0
24.0	1.20	2.40	4.80	9.60	14.40	24.0	48.0	72.0
38.0	1.90	3.80	7.60	15.20	22.80	38.0	76.0	114.0
65.0	3.25	6.50	13.00	26.00	39.00	65.0	130.0	195.0
78.0	3.90	7.8	15.60	31.20	46.80	78.0	156.0	234.0
130.0	6.50	13.00	26.00	52.00	78.00	130.0	260.0	390.0

**Table 5.**

Time VPC	Watts/Ah/Cell						NP Range 25°C						
	5M	10M	15M	20M	25M	30M	35M	40M	45M	60M	2HRS	3HRS	5HRS
1.6	5.421	3.884	3.074	2.554	2.211	1.943	1.767	1.621	1.490	1.201	0.721	0.524	0.346
1.63	5.303	3.864	3.016	2.533	2.191	1.938	1.747	1.611	1.471	1.198	0.716	0.521	0.343
1.65	5.268	3.806	2.984	2.513	2.178	1.914	1.743	1.602	1.458	1.194	0.713	0.518	0.341
1.67	5.173	3.740	2.952	2.503	2.159	1.895	1.728	1.589	1.445	1.186	0.708	0.515	0.339
1.69	5.056	3.712	2.922	2.477	2.128	1.881	1.705	1.580	1.432	1.174	0.704	0.513	0.337
1.7	4.945	3.632	2.907	2.467	2.116	1.872	1.702	1.567	1.422	1.171	0.700	0.511	0.335
1.75	4.692	3.551	2.822	2.372	2.048	1.819	1.648	1.517	1.373	1.151	0.682	0.496	0.326
1.8	4.493	3.389	2.559	2.272	1.964	1.754	1.579	1.444	1.318	1.086	0.658	0.478	0.314
1.85	4.130	3.163	2.526	2.144	1.857	1.655	1.482	1.350	1.240	1.023	0.622	0.459	0.300

**Calculation of battery size required for Constant Power load conditions.**

Using Table 5 "Watts/Cell/Ah", map the required load time to the specified end of discharge voltage. The figure obtained is the Constant Power available from each 1Ah of NP type cell. Divide this number into the required wattage load per cell to give the minimum value of capacity required to supply the required load.

Example: 5.3kW load requires 30 minutes standby operating from maximum 272V down to end of discharge 204V at 25°C.

1. Recommended float voltage for NP batteries at 25°C is 2.26volts per cell. To find the number of series cells required, divide the maximum load voltage by 2.26v.  
 $272/2.26 = 120$  cells
2. Divide the end voltage by the number of cells to find the value of end volts per cell  
 $204/120 = 1.7$ vpc
3. Divide specified load by number of cells to find load in watts per cell  
 $5,300/120 = 44.17$ wpc
4. Map end vpc "1.7" against required load time "30 mins" in Table 5:  
1.872watts per cell per Ah
5. Divide load in wpc by value from Table 5  
 $44.17/1.872 = 23.59$ Ah
6. Select the battery from the list on page 3  
20 x NP24-12 is the minimum requirement

**Table 6. DISCHARGE CAPACITY AT VARIOUS DISCHARGE RATES**

20 Hr. Capacity	Discharge Current				
	20 Hr.	10 Hr.	5 Hr.	3 Hr.	1 Hr.
	0.05CA to 1.75V/C	0.093CA to 1.75V/C	0.17CA to 1.70V/C	0.25CA to 1.67V/C	0.60CA to 1.55V/C
0.8 Ah	0.8 Ah	0.74 Ah	0.68 Ah	0.62 Ah	0.48 Ah
1.0	1.0	0.93	0.85	0.77	0.60
1.2	1.2	1.11	1.02	0.93	0.7
2.1	2.1	1.9	1.8	1.61	1.3
2.0	2.0	1.85	1.70	1.55	1.2
2.3	2.3	2.13	1.96	1.78	1.4
2.8	2.8	2.6	2.4	2.15	1.7
3.0	3.0	2.78	2.55	2.33	1.8
4.0	4.0	3.70	3.40	3.10	2.4
7.0	7.0	6.48	5.95	5.43	4.2
8.0	8.0	7.40	6.80	6.20	4.8
10.0	10.0	9.25	8.50	7.75	6.0
12.0	12.0	11.10	10.20	9.30	7.2
17.0	17.0	15.73	14.45	13.18	10.2
24.0	24.0	22.20	20.40	18.50	14.4
38.0	38.0	35.15	32.30	29.30	22.8
65.0	65.0	60.13	55.25	50.10	39.0
78.0	78.0	72.15	66.3	60.47	46.8
130.0	130.0	120.25	110.50	100.21	78.0

**Over Discharge (Deep Discharge)**

The dotted line in Figure 3 indicates the lowest recommended voltage under load, or cut off voltage, for NP batteries at various discharge rates. In general, lead acid batteries are damaged in terms of capacity and service life if discharged below the recommended cut off voltages. It is generally recognised that all lead calcium alloy grid batteries are subject to over discharge damage. For example, if a lead acid battery were discharged to zero volts, and left standing in either "on" or "off" load

conditions for a long period of time, severe sulphation would occur, raising the internal resistance of the battery abnormally high. In such an extreme case, the battery may not accept charge. NP batteries have been designed to withstand some levels of over-discharge. However, whilst this is not the recommended way of operation, Yuasa NP batteries can recover their capacity when recharged correctly. Final discharge voltage is shown in Table 7.

**Table 7. FINAL DISCHARGE VOLTAGE**

Discharge Current	Final Discharge Voltage (V/Cell)
0.1C or below, or intermittent discharge	1.75
0.17C or current close to it	1.70
0.26C or current close to it	1.67
0.6C or current close to it	1.60
Current in excess of 3C	1.30
For intermediate values, see figure 3 on page 6	see figure 3 on page 6

If a battery is to be discharged at a rate in excess of 3C Amps, please contact us prior to use.

■ **Temperature Characteristics**

At higher temperatures, the electrical (Ah) capacity of a battery increases and conversely at lower temperatures, the electrical (Ah) capacity of a battery decreases.

Figure 4 shows the effects of different temperatures in relation to battery capacity.

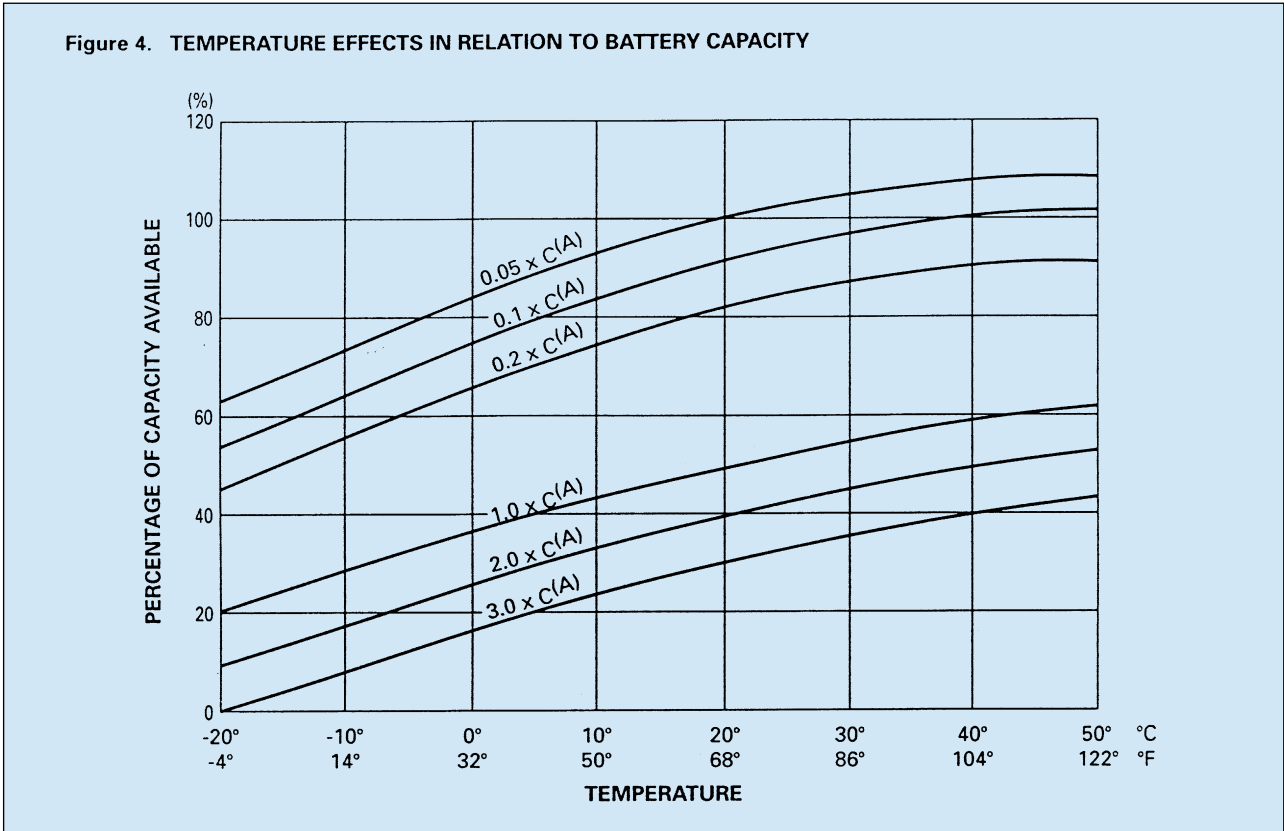

**STORAGE, SELF DISCHARGE and SHELF LIFE**

■ **Self Discharge**

The self discharge rate of NP batteries is approximately 3% per month when stored at an ambient temperature of 20°C. The self discharge rate will vary as a function of

ambient storage temperature. Figure 5 shows the relationship between storage times at various temperatures and the remaining capacity.

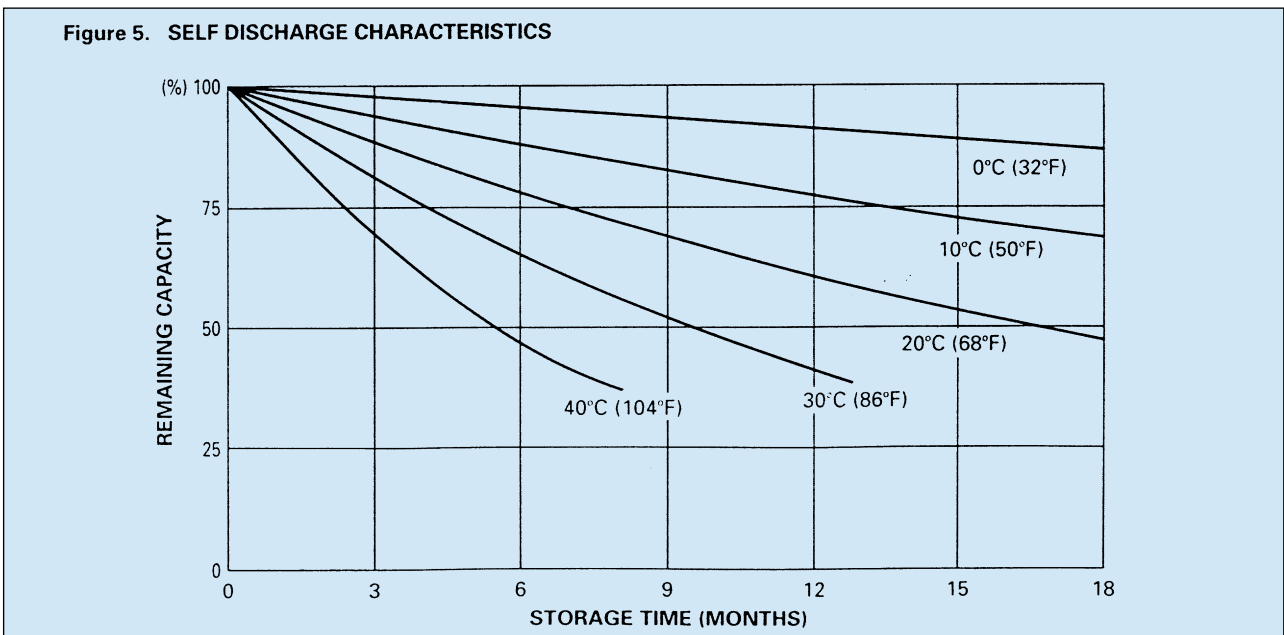

■ **Shelf Life**

In general, when lead acid batteries of any type are stored for extended periods of time, lead sulphate is formed on the negative plates of the batteries. This phenomenon is referred to as "sulphation". Since the lead sulphate acts as an insulator, it has a direct detrimental effect on charge acceptance. The more advanced the sulphation, the lower the charge acceptance.

Table 8 below shows the normal storage time or shelf life at various ambient temperatures.

**Table 8. Shelf Life at Various Temperatures**

Temperature	Shelf Life
0°C ( 32°F) to 20°C ( 68°F)	12 months
21°C ( 70°F) to 30°C ( 86°F)	9 months
31°C ( 88°F) to 40°C (104°F)	5 months
41°C (106°F) to 50°C (122°F)	2.5 months

Brief excursions i.e., a few days, at temperatures higher than the ranges recommended will have no adverse effect on storage time or service life. However, should the higher ambient temperature persist for one month or more, the storage time must be determined by referring to the new ambient temperature. Ideally NP batteries should be stored in dry, cool conditions.

■ **Recharging Stored Batteries**

In general, to optimise performance and service life, it is recommended that NP batteries which are to be stored for extended periods of time be given a supplementary charge, commonly referred to as a "top charge", periodically. Please refer to the recommendations listed on page 24 under Top Charging.

Figure 6. TEMPERATURE/LIFE CHARACTERISTICS OF NP BATTERIES

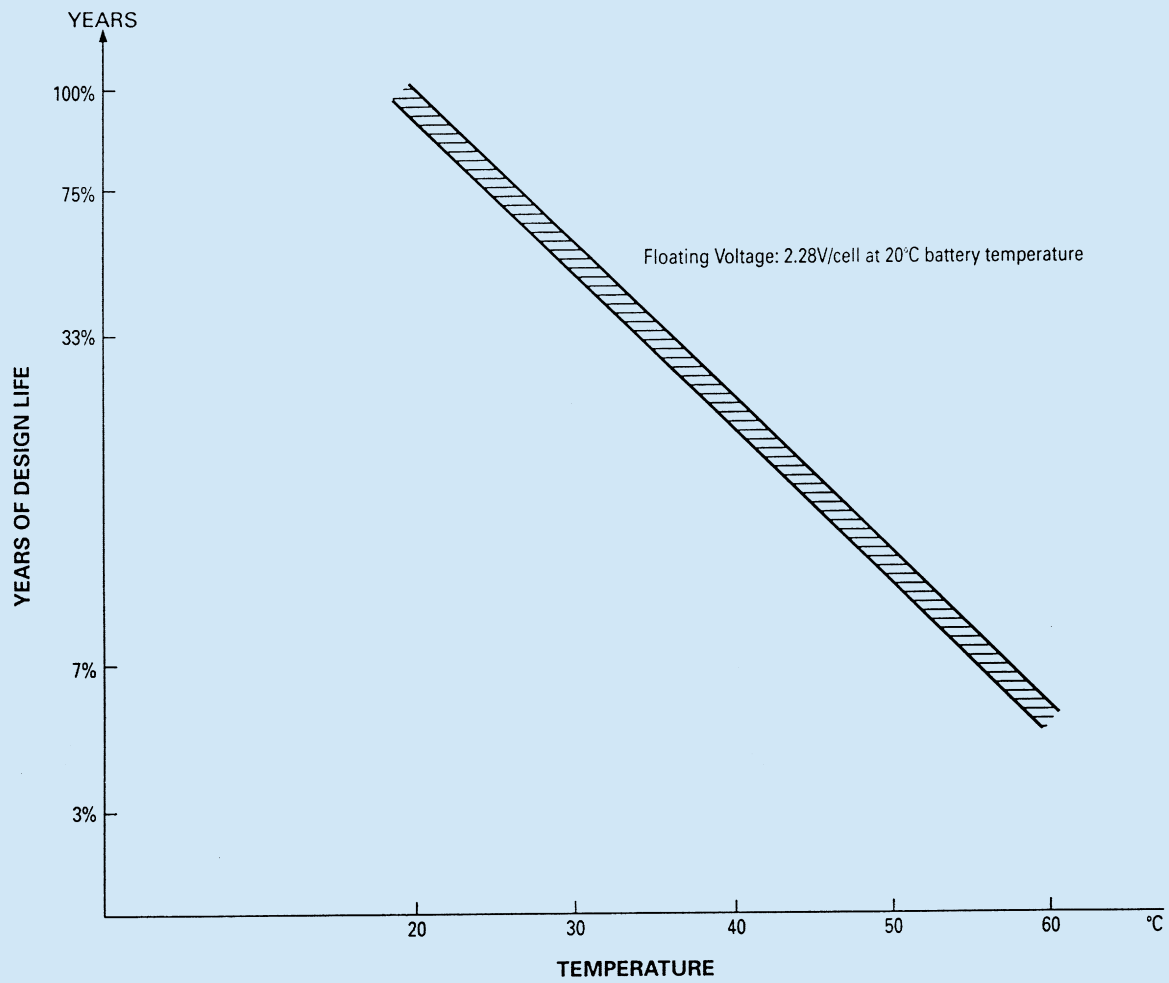
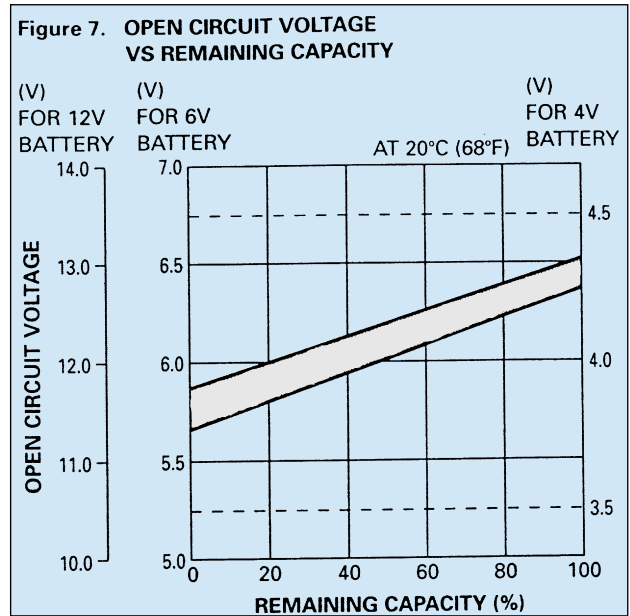

Figure 6 shows extrapolated Service Life condition for NP batteries at different ambient temperatures. As can

be seen from figure 6 higher ambient temperatures will reduce service life.

## AVAILABLE CAPACITY, MEASURED BY OPEN CIRCUIT VOLTAGE

The approximate depth of discharge, or remaining capacity, in a Yuasa NP battery can be empirically determined by referring to Figure 7.



## IMPEDANCE

The internal resistance (impedance) of a battery is lowest when the battery is in a fully charged state. The internal resistance increases gradually during discharge, Figure 8

shows the internal resistance of an NP6-12 battery measured through a 1,000 Hz AC bridge.

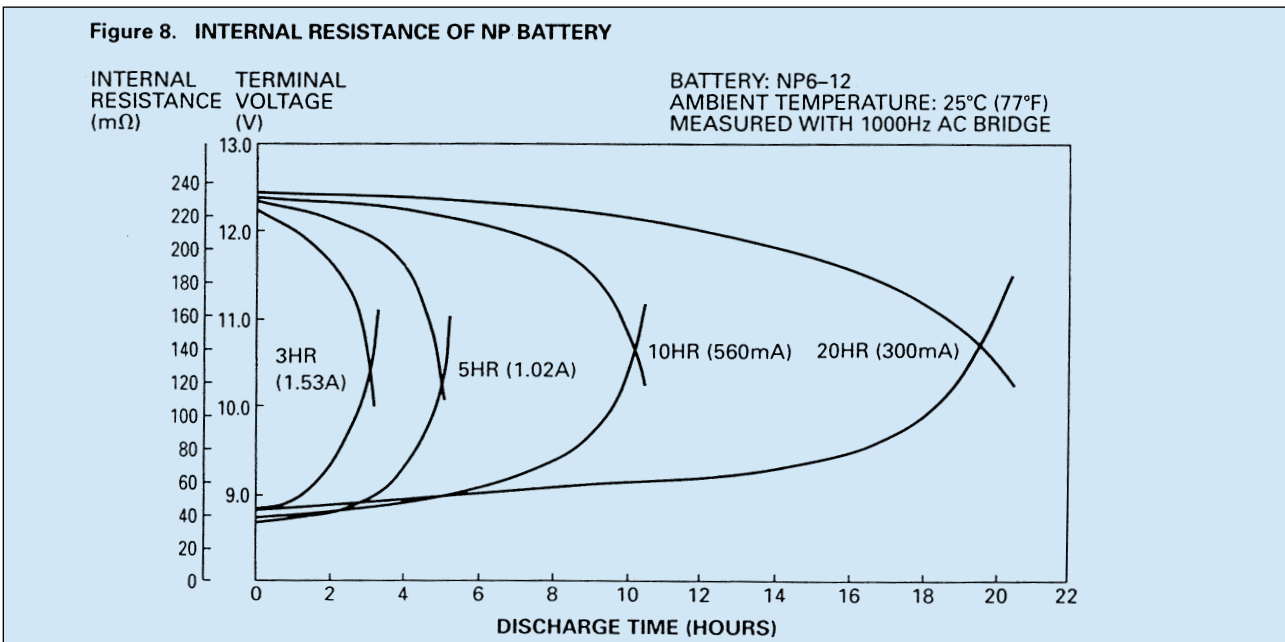

Impedance testing can be performed using the Yuasa YPI-2 Impedance/comparator test meter, this form of testing is non-intrusive and can be performed online with the battery still connected within its system. (Note: The YPI-2 meter can

not be used where a high AC ripple content exists.) By using this test method deterioration can be detected without removing the battery from its standby mode.

## CHARGING

Correct charging is one of the most important factors to consider when using valve regulated lead acid batteries. Battery performance and service life will be directly affected by the efficiency of the charger selected. The basic charging methods are:

- Constant Voltage Charging
- Constant Current Charging
- Taper Current Charging
- Two Stage Constant Voltage Charging

### ■ Constant Voltage Charging

Charging at constant voltage is the most suitable and commonly used method for charging valve regulated lead acid batteries. Figures 10 - 15 show the charging characteristics of NP batteries when charged by constant voltage chargers at 2.275 volts/cell, 2.40 volts/cell and 2.50 volts/cell when the initial charging current is controlled at 0.1C Amps and 0.25C Amps.

Figure 9 shows one example of a constant voltage charging circuit. In this circuit, the initial charging current is limited by the series resistance R1.

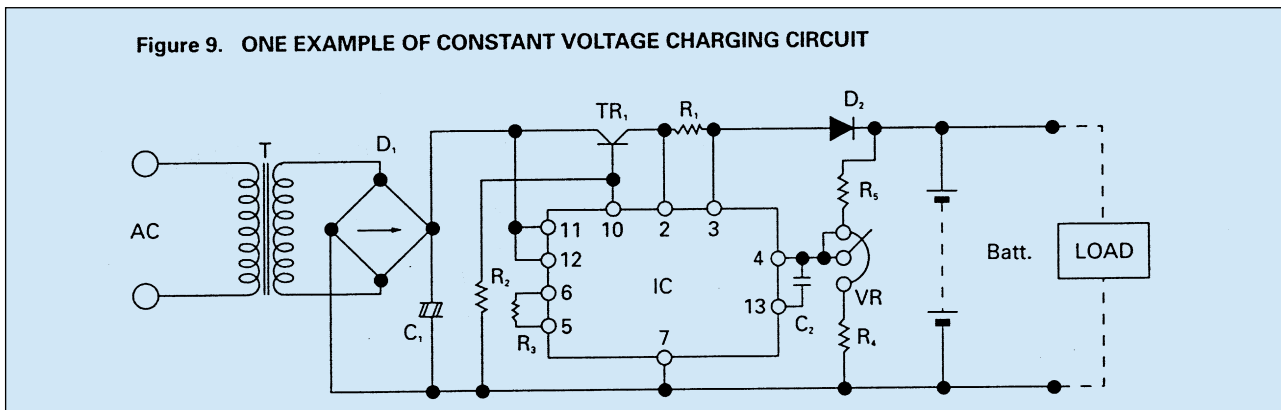

### Note

The recommended float charge voltage for NP type batteries at 20°C is 2.275vpc ± 0.005v. this should be the measured average for the total battery, however when measured within a battery network or string the allowable tolerances can be expected between 2.25vpc and 2.3vpc.



Figure 10. CHARGING CHARACTERISTICS

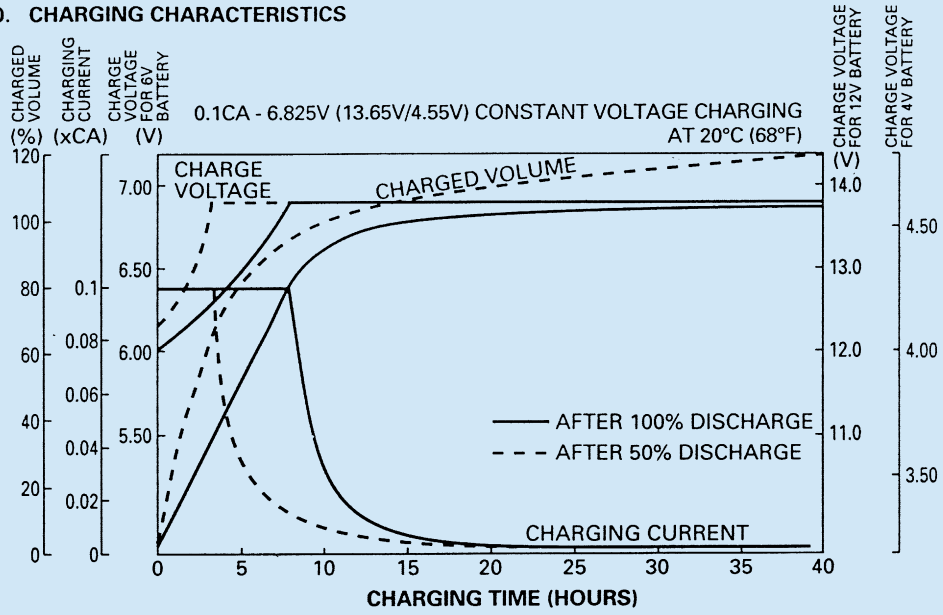
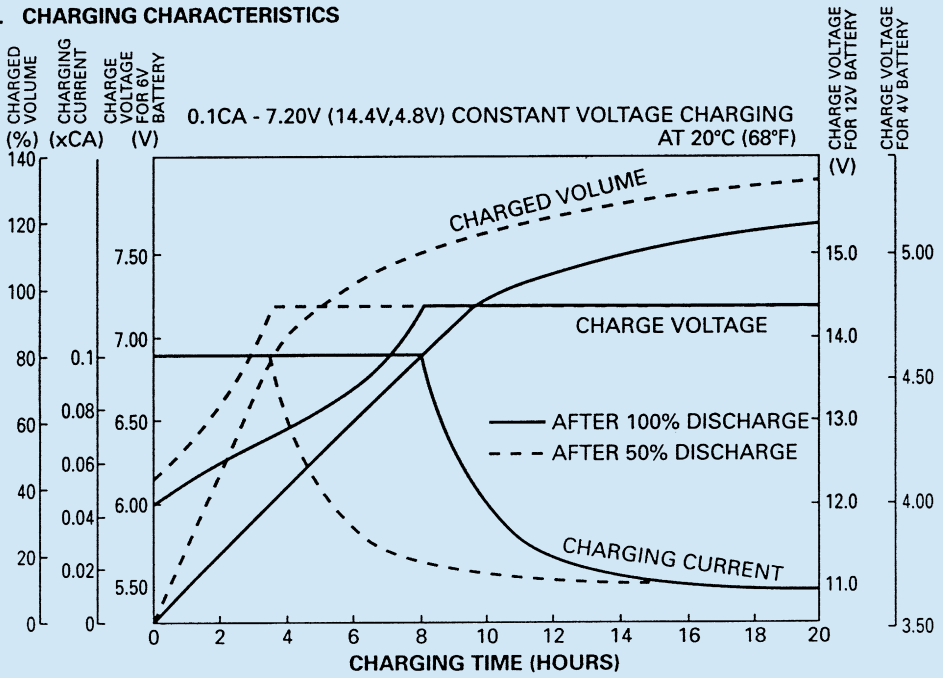
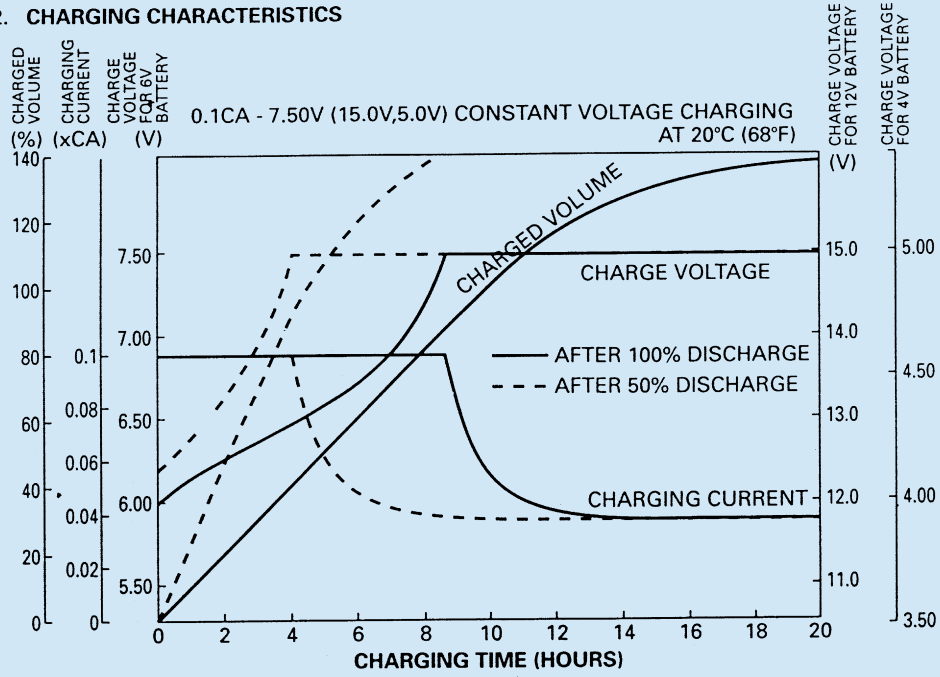

Figure 11. CHARGING CHARACTERISTICS



**Figure 12. CHARGING CHARACTERISTICS**



**Figure 13. CHARGING CHARACTERISTICS**

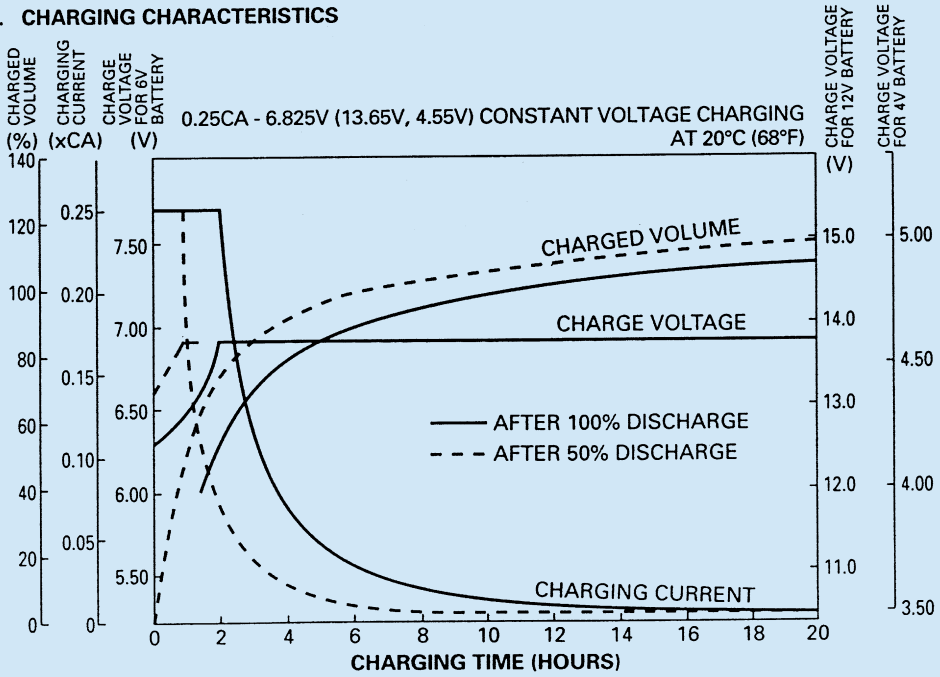

Figure 14. CHARGING CHARACTERISTICS

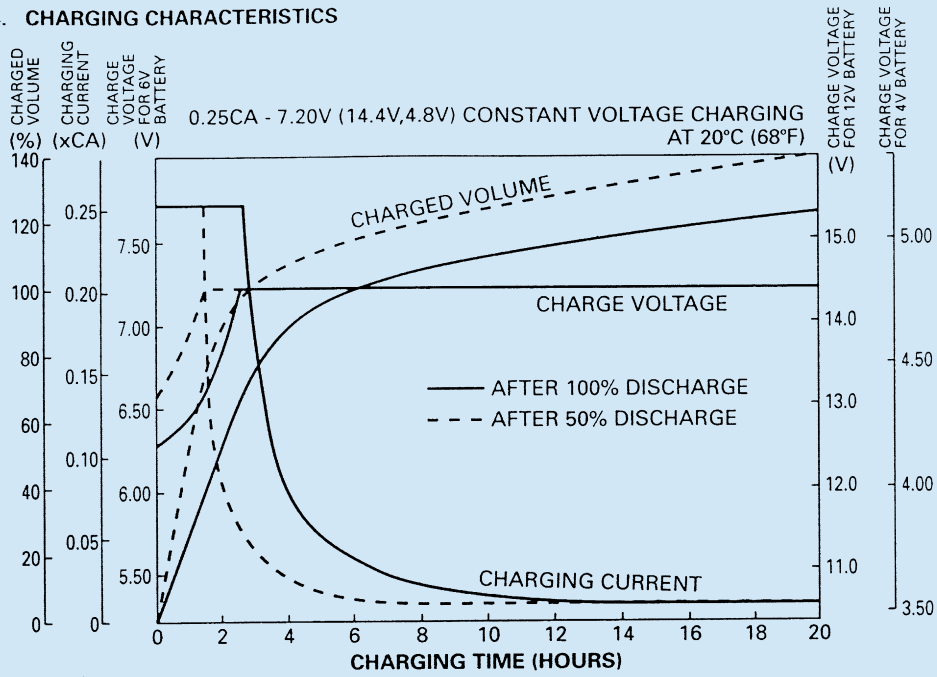
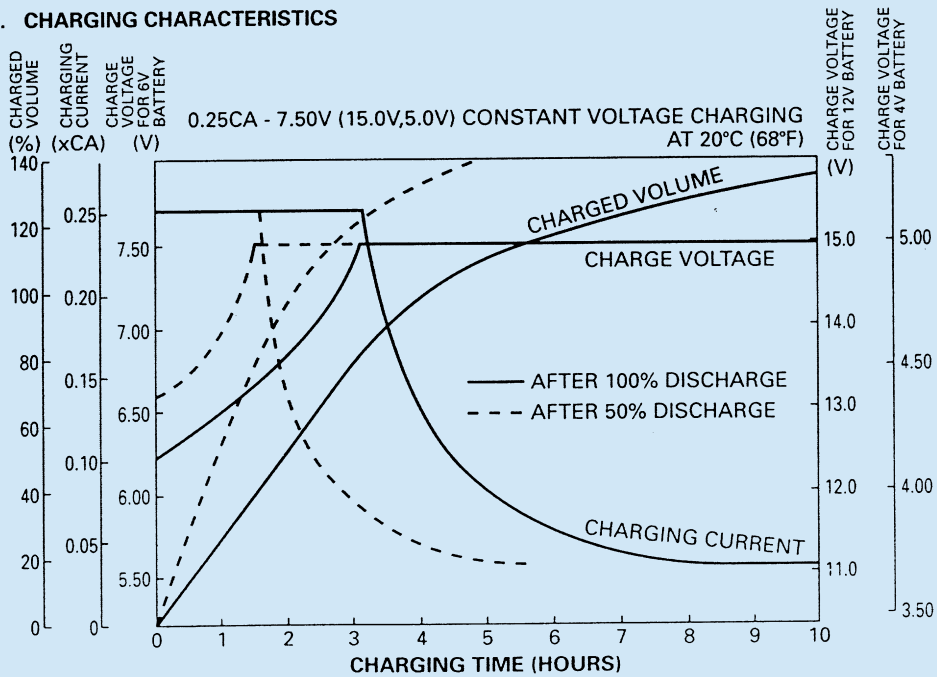

Figure 15. CHARGING CHARACTERISTICS



■ **Constant Current Charging**

This charging method is not often utilised for valve regulated lead acid batteries, but is an effective method for charging a number of series connected batteries at the same time, and/or as an equalising charge to correct variances in capacity between batteries in a series group.

Extreme care is required when charging NP batteries

with a constant current. If, after the battery has reached a fully charged state, the charge is continued at the same rate, for an extended period of time, severe overcharge may occur, resulting in damage to the battery. Figure 16 shows a typical constant current charging circuit; Figure 17 shows the characteristics of two NP6-12 batteries under continuous overcharge conditions.

Figure 16. CONSTANT CURRENT CHARGING CIRCUIT

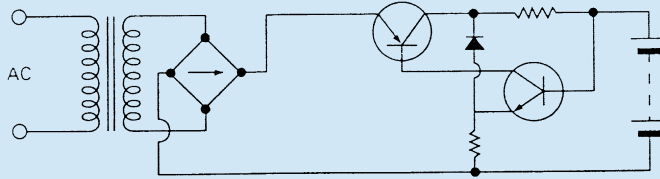
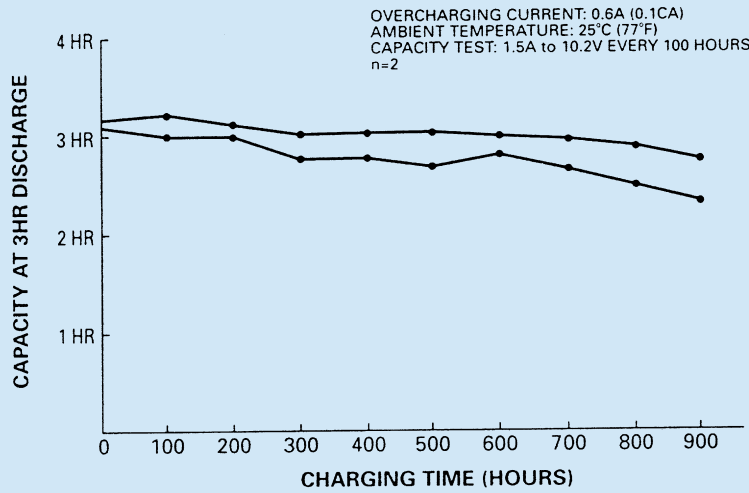

Figure 17. CHARACTERISTICS OF TWO NP6-12 UNDER CONDITIONS OF CONTINUOUS OVERCHARGE



### ■ Taper Current Charging

This method of charging is not recommended due to the constant current characteristics of taper charging being somewhat harsh on valve regulated lead acid batteries. This particular charging regime can often shorten battery service life. However, because of the simplicity of the circuit and subsequent low cost, taper current charging is often used to charge a number of series connected batteries that are subject to cyclic use. When using a taper charger it is recommended that the charging time is either limited or that a charging cut-off circuit be

incorporated to prevent overcharge. Please consult us for specific recommendations.

In a taper current charging circuit, the charging current decreases gradually and the charging voltage rises proportionately as the charge progresses. When designing a taper charger it should be borne in mind that variations in the mains input supply will be reflected in the output of the charger. Figure 18 illustrates the characteristics of a typical taper charger.

Figure 18. CHARGING CHARACTERISTICS OF A TAPER CHARGER

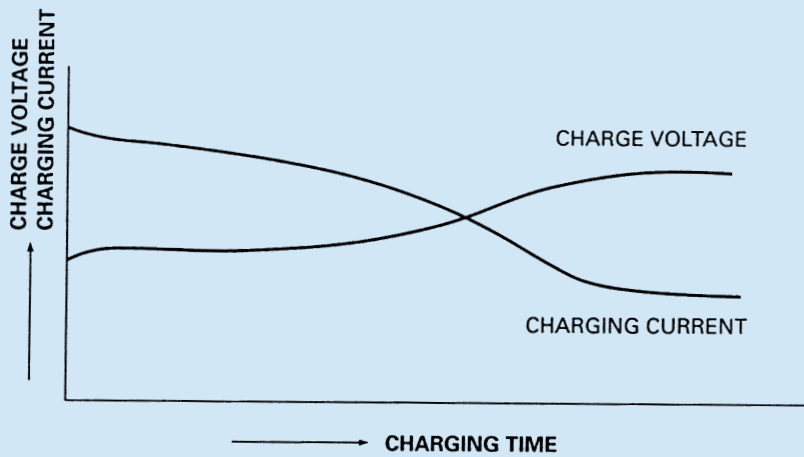
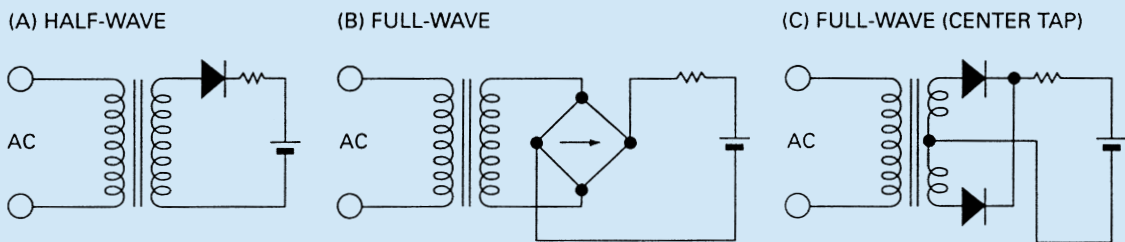

Figure 19. TAPER CURRENT CHARGING CIRCUITS



■ **Two Stage Constant Voltage Charging**

Two stage constant voltage charging is a recommended method for charging valve regulated lead acid batteries in a short period of time and then maintaining them in a

fully charged float or standby condition. Figure 20 illustrates the characteristics of a two stage constant voltage charger.

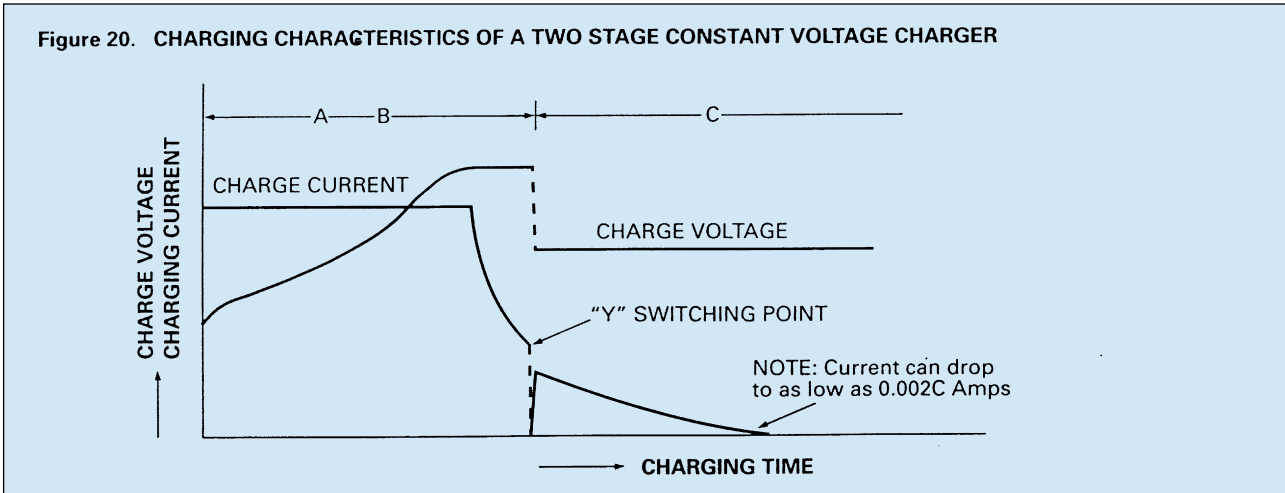

The characteristics shown in Fig.20 are those of a constant voltage, current limited charger. In the initial charging stage, the current flowing into the battery is limited to a value of 0.25C Amps. The charging voltage across the battery terminals rises, during the charging process, to a value equal to the constant voltage output of the charger, which is set to 2.45 volts per cell. Whilst continuing to charge, in stage 1 (A-B), at 2.45 volts per cell, the current will eventually decrease to point "Y", where the value of this decreasing current is "sensed" causing the circuit to

switch into the second stage (B-C), reducing the charging voltage from 2.45 volts per cell to a constant voltage, float/standby, level of 2.3 volts per cell. The switch to stage two, where the constant voltage level of 2.3 volts per cell is applied, occurs after the battery has recovered about 80% of its rated capacity. This is one of the most efficient charging methods available as the recharge time is minimised during the initial stage whilst the battery is protected from overcharge by the system switching to stage 2 (float/standby) charge at the switching point "Y".

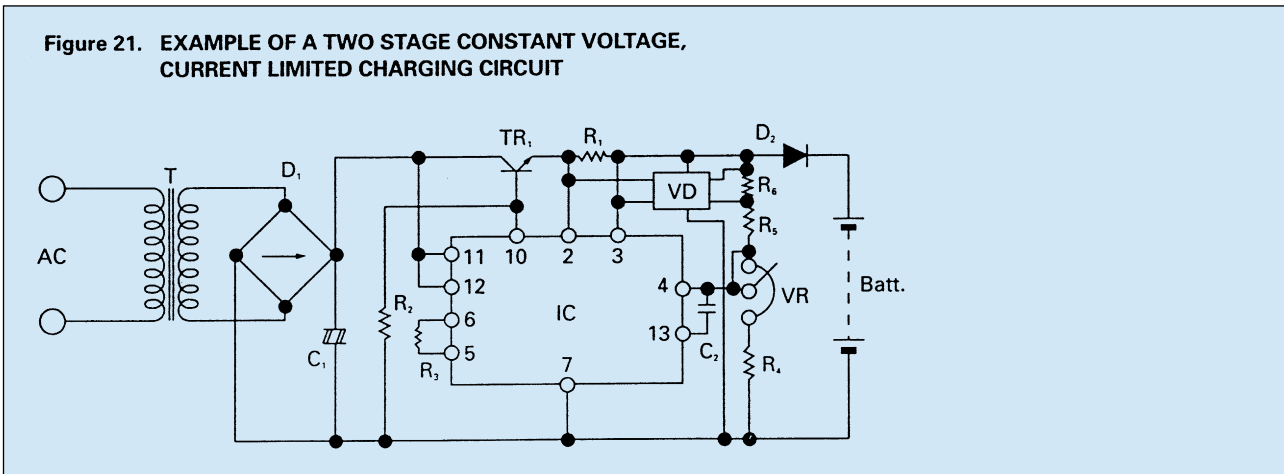

When this charging method is used, the output values will be as follows:

- Initial Charge Current . . . . . 0.25C Amps (max).
- Charge Voltage:-
  - 1st Stage . . . . . 2.45v/cell (2.40 to 2.50 v/cell, max.)
  - 2nd Stage . . . . . 2.27vpc ± 0.005

Switching Current From  
1st Stage to 2nd Stage . . . . . 0.05C Amps  
(0.04C to 0.08C Amps)

Note: This charging method cannot be used in applications where the load and the battery are connected in parallel.

■ YUASA C.V.C.C. CONSTANT VOLTAGE, CONSTANT CURRENT CHARGE MODULE

The Yuasa C.V.C.C. is a fully regulated automatic charging module designed for NP batteries. There are two 6 volt versions available; one for standby applications and the other for cyclic applications. Also there are two 12 volt versions available, again one for standby applications and the other for cyclic applications. When interfaced with the appropriate AC or DC power supply, the Yuasa C.V.C.C. guarantees safe charging and maximum battery life. Figure 23 is a block diagram of the C.V.C.C.

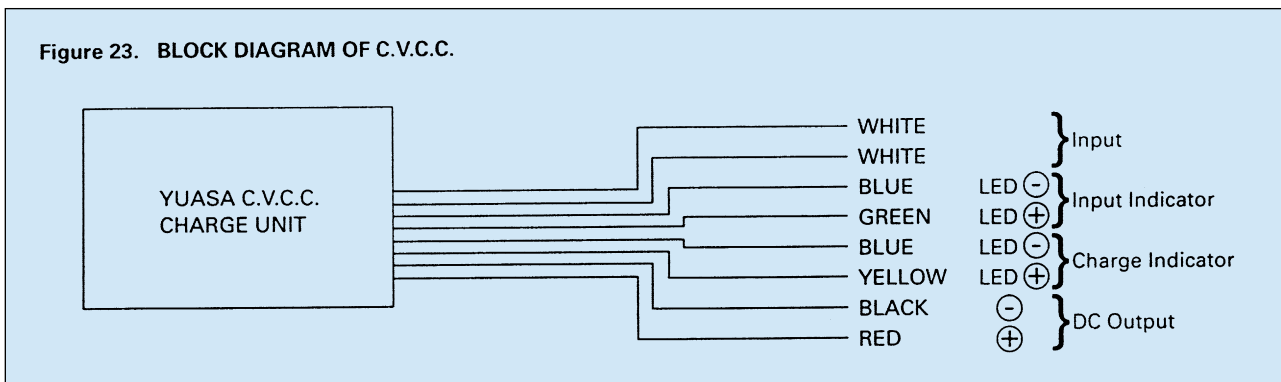

The C.V.C.C. modules are protected from both the short circuiting of their D.C. output voltage and from being

reverse polarity connected to the battery. Detailed specifications are available on request.

### ■ Solar Powered Chargers

A battery is an indispensable component of any solar powered system designed for demand energy use. Since solar cells have inherent constant voltage characteristics, NP batteries can be charged directly from the solar array using a simple diode regulated circuit as shown in Figure 24.

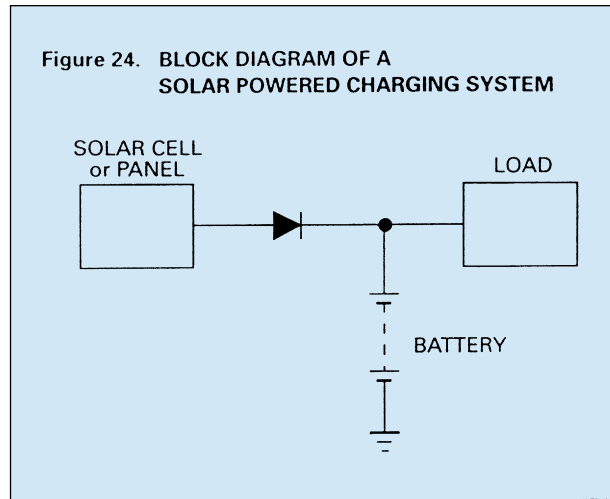

In designing a solar powered system, consideration should be given to the fact that in addition to normal periods of darkness, weather conditions may be such that solar energy is limited, or virtually unavailable for long periods of time. In extreme cases, a system may have to operate for 10 to 20 days with little or no power available for charging. Therefore, when selecting the correct battery for a solar application, the capacity should be determined based upon maximum load conditions for the maximum period of time the system may be expected to be without adequate solar input.

In many instances the battery capacity will be 10 to 50 times greater than the maximum output of the solar panels. Under these circumstances, the maximum output of the solar array should be dedicated to charging the battery with no load sharing or intervening control devices of any kind.

Naturally, in cases where the output of the solar array exceeds the capacity of the battery, and weather

conditions are such that the potential for overcharging the battery exists, appropriate regulated charging circuitry between the solar panels and the battery is recommended.

Remote sites and other outdoor applications is where most solar powered systems are to be normally found. When designing a solar powered system for this class of application, a great deal of consideration must be given to environmental conditions. For example, enclosures which may be used to house batteries and other equipment may be subject to extremely high internal temperatures when exposed to direct sunlight. Under such conditions, insulating the enclosure and/or treating the surface of the enclosure with a highly reflective, heat resistive material is highly recommended.

In general, when designing a solar powered system, consultation with the manufacturers of both the solar panel and the battery is strongly advised.



■ **Charging Voltage**

The charging voltage should be chosen according to the type of service in which the battery will be used. Generally, the following voltages are used:

For float (standby) use . . . . . 2.275vpc ± 0.005 volts per cell  
 For cyclic use . . . . . 2.40 to 2.50 volts per cell

In a constant voltage charging system, a large amount of current will flow during the initial stage of charging but will decrease as the charging progresses. When charging at 2.275 volts per cell, the current at the final stage of charging will drop typically to a value of between 0.0005C Amps and 0.004C Amps. The charged volume in ampere hours, shown on the vertical axis of Figures 10 - 15 (pages 14-16), indicate the ratio of charged ampere hours to the previously discharged ampere hours. When a battery has been charged up to a level of 100% of the discharged ampere hours, the electrical energy stored and available for discharge will be 90% or more, of the energy applied during charging. Charging voltage should be regulated in relation to the ambient temperature. When

the temperature is higher, the charging voltage should be lower and conversely when the temperature is lower, the charging voltage should be higher. For specific recommendations, please refer to the section on Temperature Compensation on page 25. Similarly, charged volume (measured in ampere hours) realised over a given time will vary in direct relation to the ambient temperature; the higher the ambient temperature, the higher the charged volume in a given period of time and the lower the ambient temperature, the lower the charged volume in the same given period of time. Figure 25 shows the relationship between charged volume and temperature.

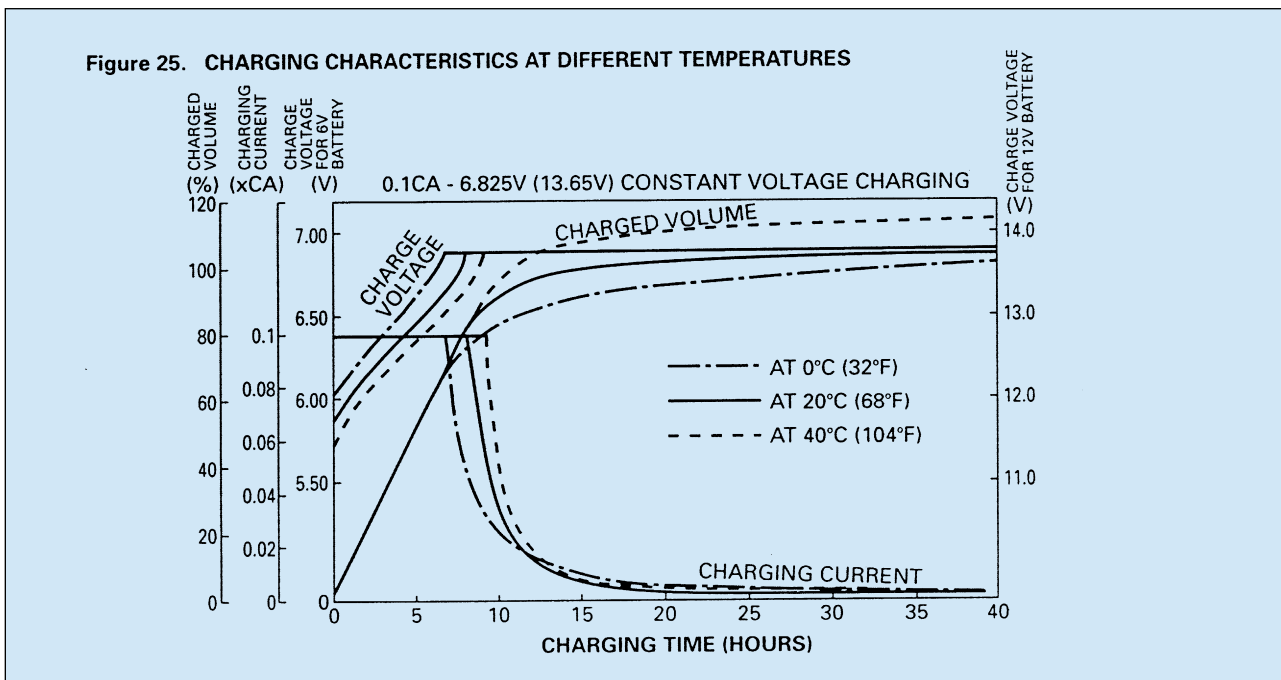

■ **Initial Charge Current Limit**

A discharged battery will accept a high charging current at the initial stage of charging. High charging current can cause abnormal internal heating which may damage the battery. Therefore, when applying a suitable voltage to recharge a battery that is being used in a recycling application it is necessary to limit the charging current to a value of 0.25C Amps. However, in float/standby use, Yuasa NP batteries are designed so that even if the available charging current is higher than the recommended limit, they will not accept more than 2C Amps and the charging current will fall to a relatively small value in a very brief period of time. Normally, therefore, in the majority of float/standby applications no current limit is required. Figure 26 shows current acceptance in NP batteries charged at a constant voltage of 2.30 vpc without current limit.

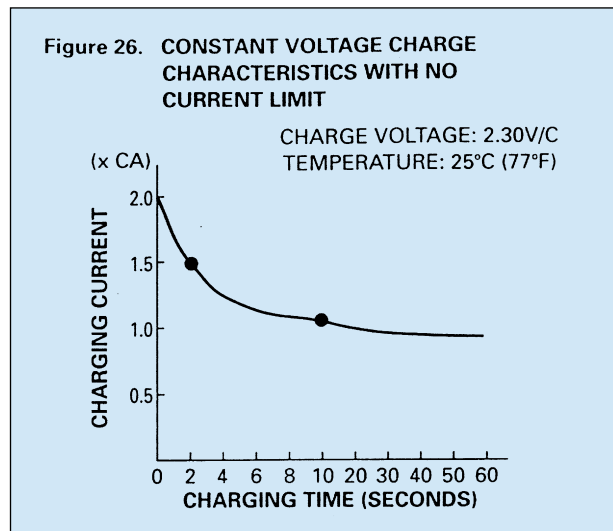

When designing a charger, it is recommended that suitable circuitry is employed to prevent damage to the charger caused by short circuiting the charger output or connecting it in reverse polarity to the battery. The use of current limiting and heat sensing circuits fitted within the charger are normally sufficient for the purpose.

■ **Charge Output Regulation and Accuracy**

To ensure the correct voltage is set accurately, when adjusting the output voltage of a constant voltage charger, all adjustments must be made with the charger "ON LOAD". Adjusting the output voltage with the charger in an "OFF LOAD" condition may result in undercharging. The constant voltage range required by a battery is always defined as the voltage range applied to a battery which is fully charged. Therefore, a charger having the output characteristics illustrated in Figure 27, should be adjusted

with the output voltage based on point A. The most important factor in adjusting charger output voltage is the accuracy at point A, which should be in the range of 2.275vpc ± 0.005 volts per cell; however this accuracy is not normally required over the entire range of the load. A charger adjusted in accordance with Figure 27 will never damage a battery, even if the charger has the characteristics shown by the broken line in Figure 27.

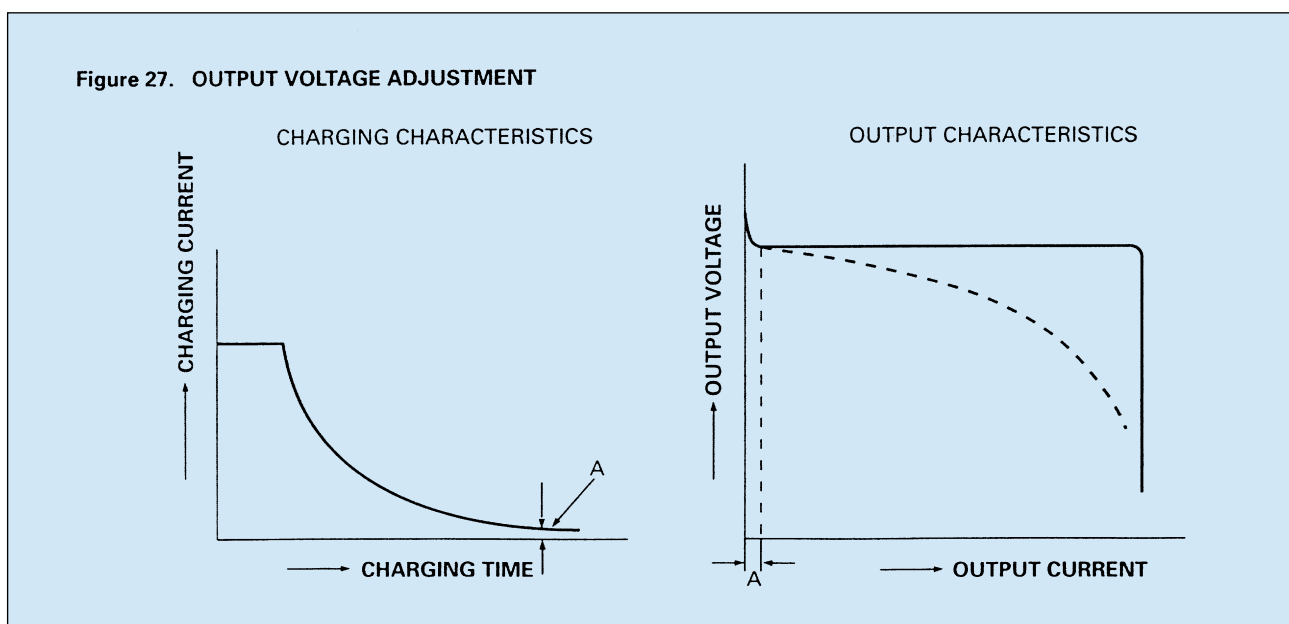

■ **Top Charging**

Since any battery loses capacity through self discharge, it is recommended that, prior to putting the battery into service, a process called "top charging" be applied to any battery which has been stored for a long period of time.

Excluding conditions in which storage temperatures have been abnormally high, top charging is recommended within the following parameters:

Battery Age	Top Charging Recommendations
Within 6 months after manufacture	4 to 6 hours at constant current of 0.1C Amps or 15 to 20 hours at constant voltage of 2.40 vpc
Within 12 months after manufacture	8 - 10 hours at constant current of 0.1C Amps or 20 to 24 hours at constant voltage of 2.40 vpc

In order to successfully top charge a battery stored for more than 12 months, the open circuit voltage must be checked to ensure that it is higher than 2.0 volts per cell.

Therefore ALWAYS check the open circuit voltage FIRST. If the open circuit voltage of the battery is 2.0 vpc or lower, please refer to us prior to attempting to "Top Charge".

■ **Recovery Charge After Deep Discharge**

When a battery has been subjected to deep discharge (commonly referred to as over discharge), the amount of electrical energy which has been discharged can be 1.5 to 2.0 times greater than the rated capacity of the battery. Consequently, a battery which has been over discharged requires a longer charging period than normal. Please note from Figure 28 that as a result of increased internal

resistance, the charging current accepted by an over discharged NP battery during the initial stage of charging will be quite small, but will increase rapidly over approximately the first 30 minutes until the internal resistance has been overcome, then normal, full recovery charging characteristics resume.

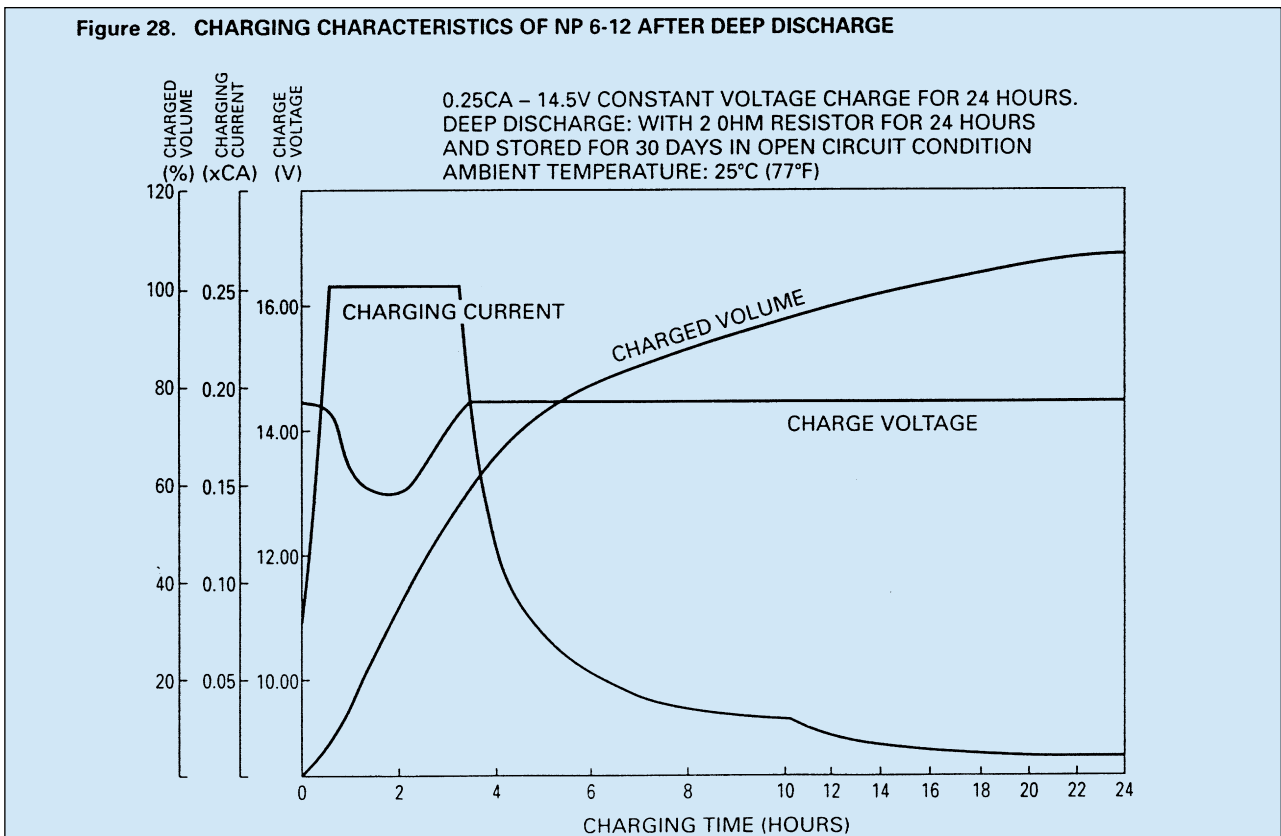

Because of this initial small charge current, in an over discharged battery, as described above, unless due consideration is given to this fact then if the charging regime uses current monitoring for determining either the state of charge and/or for signalling that the switching point has been reached for reducing the voltage to a

float/standby value (as is the normal case in a multi-stage charger), the charger could be 'tricked' into entering further stages before completing earlier ones. In other words the charger may give a false "full charge" indication, or may initiate charge at the float voltage figure, instead of at a higher voltage level.

■ **Temperature Compensation**

As the temperature rises, electrochemical activity in a battery increases and conversely decreases as temperature falls. Therefore, as the temperature rises, the charging voltage should be reduced to prevent overcharge and increased, as the temperature falls, to avoid undercharge. In general, in order to attain optimum service life, the use of a temperature compensated charger is recommended. The

recommended compensation factor for NP batteries is  $-3\text{mV}/^\circ\text{C}/\text{Cell}$  (for float/standby) and  $-4\text{mV}/^\circ\text{C}/\text{Cell}$ . (cyclic use). The standard centre point for temperature compensation is  $20^\circ\text{C}$ . Figure 29 shows the relationship between temperatures and charging voltages in both cyclic and float/standby applications.

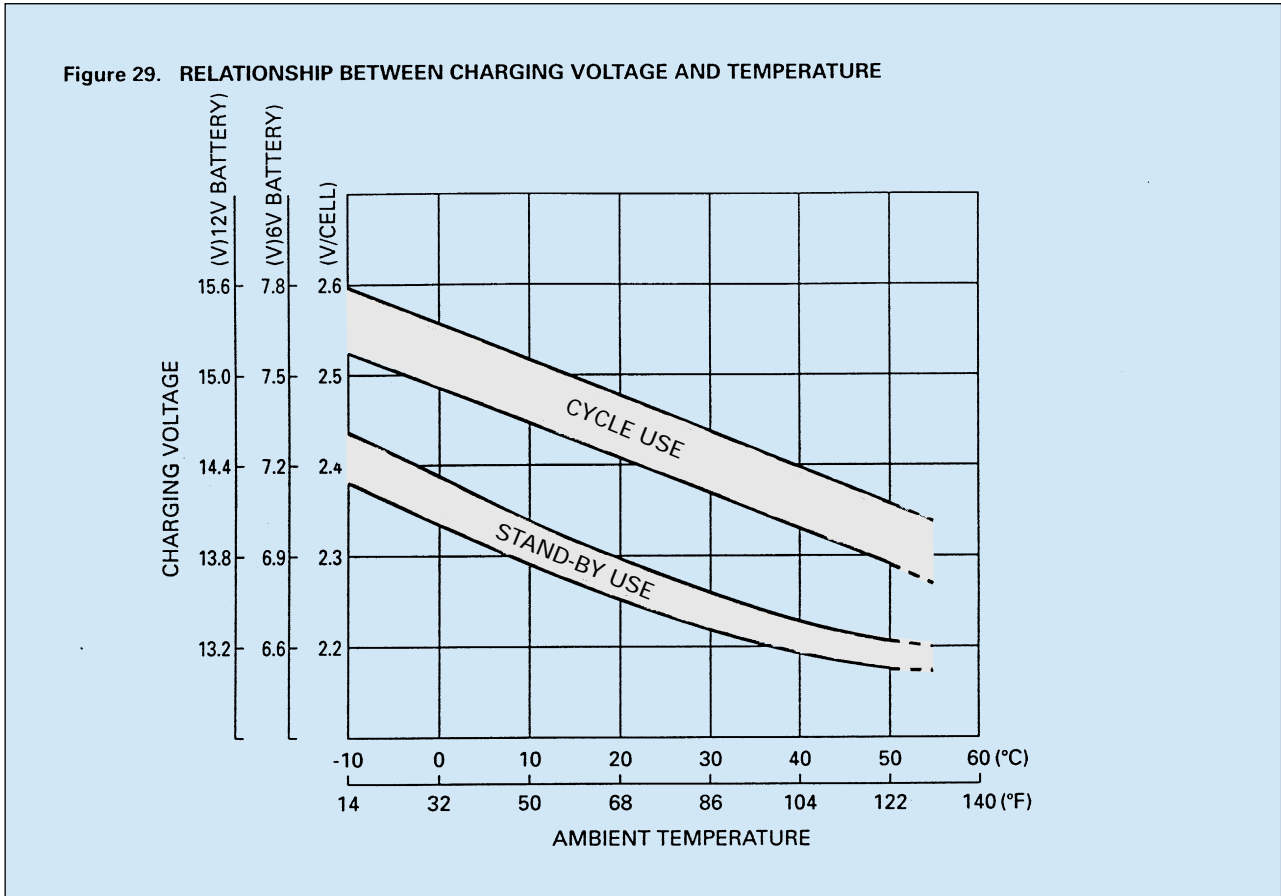

In practice where there are short term temperature fluctuations between  $5^\circ\text{C}$  and  $40^\circ\text{C}$ , temperature compensation is not absolutely essential. However, it is desirable to set the voltage at a value shown in Figure 29 which, as closely as possible, corresponds to the average ambient temperature of the battery during its service life.

When designing a charger equipped with temperature compensation, the temperature sensor must sense only the temperature of the battery. Therefore, consideration should be given to thermally isolating the battery and temperature sensor from other heat generating components in the system.

■ **Charging Efficiency**

The charging efficiency ( $\eta$ ) of a battery is expressed by the following formula:

$$\eta = \frac{\text{(Ah) Ampere hours Discharged}}{\text{(Ah) Ampere hours Charged}}$$

The charging efficiency varies depending upon the state of charge of the battery, temperatures and charging rates. Figure 30 illustrates the concept of the state of charge and charging efficiency. As shown in Figure 31, Yuasa NP batteries exhibit very high charging efficiency, even at low charging rates, unlike some nickel cadmium batteries.

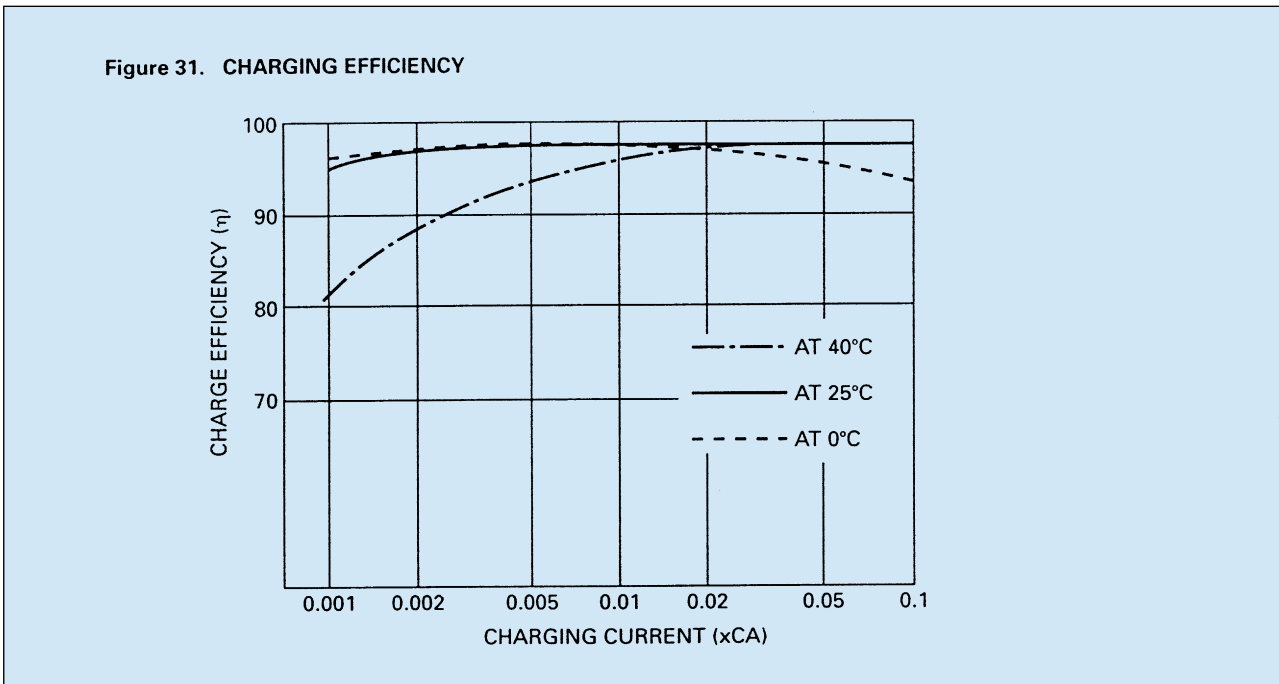
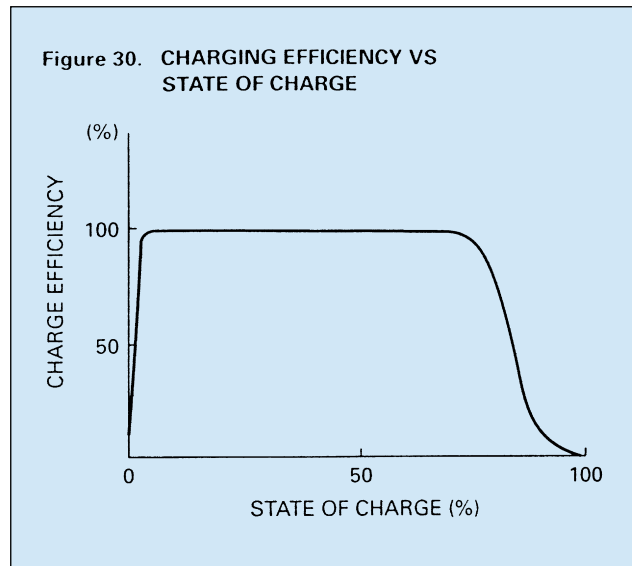

**EXPECTED SERVICE LIFE OF NP BATTERIES**

■ **Cyclic Service Life**

There are a number of factors that will affect the length of cyclic service of a battery. The most significant are ambient operating temperature, discharge rate, depth of discharge, and the manner in which the battery is recharged.

Generally speaking, the most important factor is depth of discharge. Figure 32 illustrates the effects of depth of discharge on cyclic life.

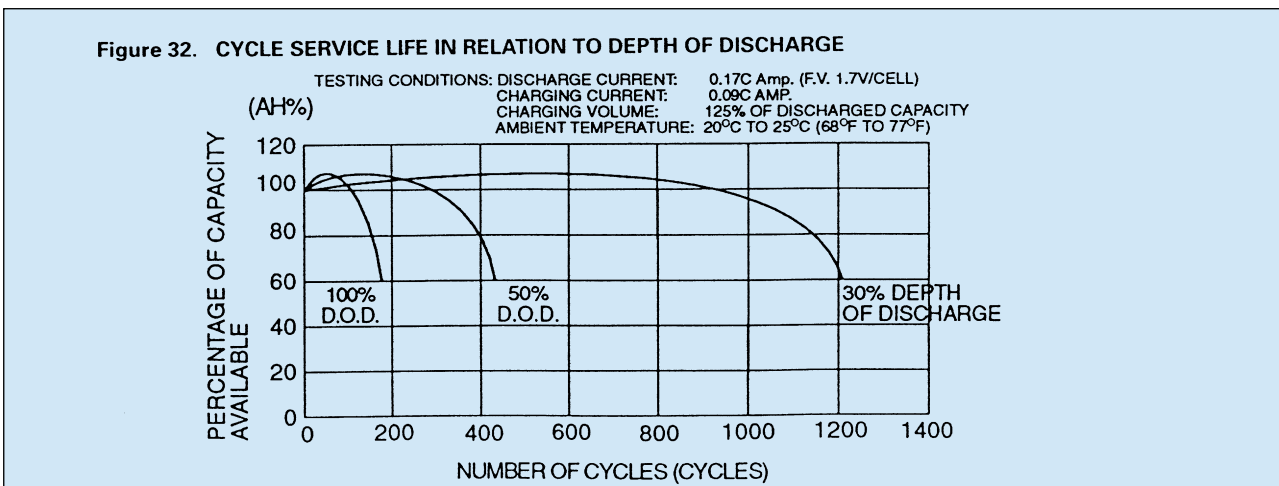

The relationship between the number of cycles which can be expected and the depth of discharge is readily apparent. If an extended cycle life is required then it is common practice to select a battery with a larger capacity

than the one that is required to carry the load. Thus, at the specified discharge rate over the specified time, the depth of discharge will be shallower and cyclic service life will be longer.

■ **Float Service Life**

NP batteries are designed to operate in float/standby service for approximately 5 yrs (NP+NPH) 7-10 yrs (NPL) based upon a normal service condition in which float charge voltage is maintained between 2.275vpc ± 0.005

volts per cell in an ambient temperature of approximately 20°C. Figure 33 shows the float service life characteristics of NP batteries when discharged once every three months to 100% depth of discharge.

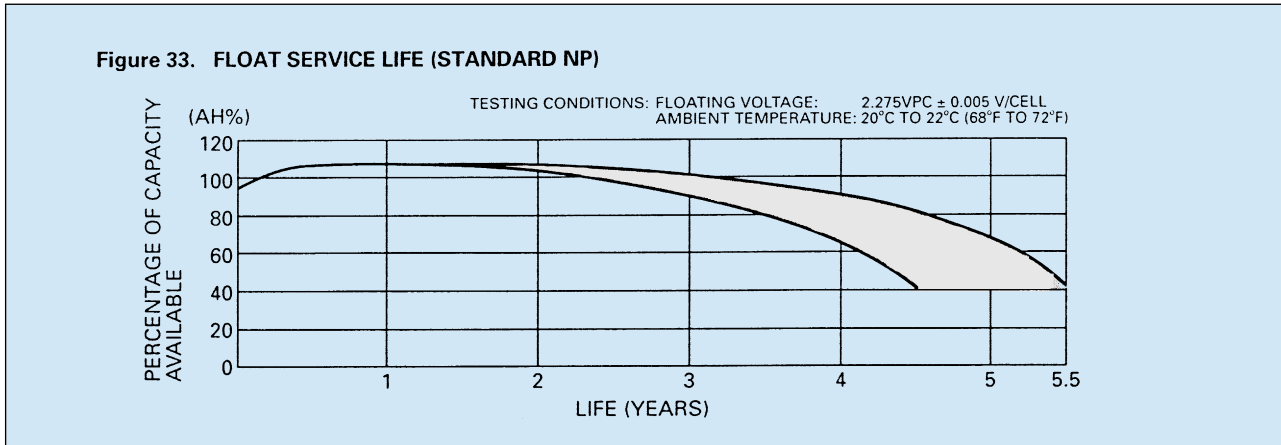

In a normal float service, where the charging voltage is maintained at 2.275vpc ± 0.005 volts per cell (see Fig. 34), the gases generated inside an NP battery are continually recombined into the negative plates and return to the water content of the electrolyte. Therefore, electrical capacity is effectively not lost due to the “drying up” of the electrolyte; the loss of capacity and eventual end of service life is brought about by the gradual corrosion of the

electrodes. It should be noted that this corrosive process will be accelerated by high ambient operating temperatures and/or high charging voltage. When designing a float service system, always consider the following: LENGTH OF SERVICE LIFE WILL BE DIRECTLY AFFECTED BY THE NUMBER OF DISCHARGE CYCLES, DEPTH OF DISCHARGE, AMBIENT TEMPERATURE AND CHARGING VOLTAGE.

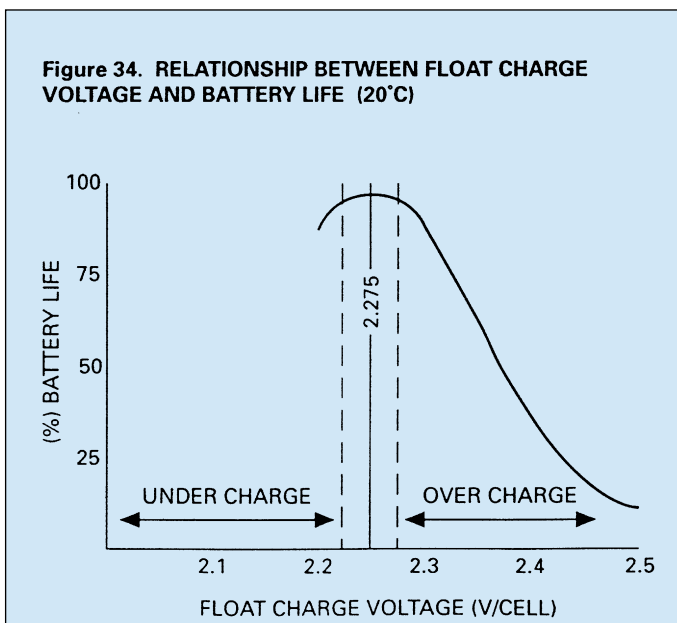

## DESIGN/APPLICATION TIPS TO ENSURE MAXIMUM SERVICE

---

Yuasa NP batteries are highly efficient maintenance free electrochemical systems designed to provide years of trouble free electrical energy. The performance and service life of these batteries can be maximised by observing the following guidelines:

1. Heat kills batteries. Avoid placing batteries in close proximity to heat sources of any kind. The longest service life will be attained where the battery temperature does not exceed 20°C. (also see notes 3 & 8 hereunder). When calculating the correct float voltage setting, whether or not temperature compensation is required, full consideration must be given to the temperature of the battery and room ambient. For the purpose of the calculation, consider the temperature of a battery on float to be 1°C. above local ambient. Also, if the battery is used in an enclosure, the temperature gradient of the enclosure itself must be included in the calculation. i.e. The operating temperature of the battery is given by: Room temperature + enclosure temperature +1°C.
2. Since a battery may generate ignitable gases, do not install close to any equipment that can produce electrical discharges in the form of sparks.
3. When the battery is operated in a confined space, adequate ventilation should be provided.
4. The battery case is manufactured from high impact ABS plastic resin. It should not be placed in an atmosphere of, or in contact with organic solvents or adhesive materials.
5. Correct terminals should be used on battery connecting wires. Soldering is not recommended but if unavoidable please refer to us for further guidance.
6. Avoid operating at temperatures outside the range -15 to +50°C. for float/standby applications and +5 to +35°C. for cyclic use.
7. When there is a possibility of the battery being subjected to heavy vibration or mechanical shock, it should be fastened securely and the use of shock absorbent material is advisable.
8. When connecting the batteries, free air space must be provided between each battery. The recommended minimum space between batteries is 0.2 inches (5mm) to 0.4 inches (10mm). In all installations due consideration must be given to adequate ventilation for the purposes of cooling.
9. When the batteries are to be assembled in series to provide more than 100V, proper handling and safety procedures must be observed to prevent accidental electric shock. (see note #15 below).
10. If 2 or more battery groups are to be used, connected in parallel, they must be connected to the load through lengths of wires, cables or busbars that have the same loop line resistance as each other. This makes sure that each parallel bank of batteries presents the same impedance to the load as any other of the parallel banks thereby ensuring correct equalisation of the source to allow for maximum energy transfer to the load.
11. Ripple current (the AC component on the DC charge current). Ideally this should be zero, as it will reduce the service life of a cell/battery, the larger the component the greater the reduction it will cause. For example 0.1C Amps R.M.S will reduce the optimum service life by a minimum 3%.  
Note 1) Ripple current can be source or load generated.  
II) Ripple current can vary with load change and is often its greatest at part load.
12. When cleaning the battery case, ALWAYS use a water dampened cloth but NEVER use oils, organic solvents such as petrol, paint thinners etc. DO NOT even use a cloth that is impregnated or has been in contact with any of these or similar substances.
13. Do not attempt to dismantle the battery. If accidental skin/eye contact is made with the electrolyte, wash or bathe the affected area/part straight away with liberal amounts of clean fresh water and seek IMMEDIATE medical attention.
14. DO NOT INCINERATE batteries as they are liable to rupture if placed into a fire. Batteries, that have reached the end of their service life, can be returned to us for safe disposal.
15. Touching electrically conductive parts might result in an electric shock. Be sure to wear rubber gloves before inspection or maintenance work.
16. The use of mixed batteries with different capacities, that may have been subjected to different uses, be of different ages and are of different manufacturers is liable to cause damage to the battery itself and/or the associated equipment. If this is unavoidable please consult us beforehand.
17. To obtain maximum life, batteries should never be stored in a discharged state.
18. In order to obtain maximum working life, when the batteries are used in an UPS system the following is advised:
  - (a) Where the D.C. input exceeds 60 volts, each battery should be insulated from the battery stand by using suitable polypropylene or polyethylene material.
  - (b) In high voltage systems the resistance between battery and stand should always be greater than 1 Megohm. An appropriate alarm circuit could be incorporated to monitor any current flow.

## GLOSSARY

---

1. Ampere (A) ..... The unit for measuring the flow of electric current.
2. Ampere hour (Ah) ..... The current in (A amperes) multiplied by time in (h hours). Used to indicate the capacity of a battery.
3. Capacity (C)..... Ampere hours that can be discharged from a battery.
4. Cell..... The minimum unit of which a battery is composed, consisting of positive and negative plates, separators, electrolyte, etc. In valve regulated lead acid batteries, the nominal voltage is 2 volts per cell.
5. Charging..... The process of storing electrical energy in a battery in a chemical form.
6. Cyclic Service ..... The use of a battery with alternative repetition of charging and discharging.
7. Cycle Service Life ..... The total number of cycles expected at a given depth of discharge.
8. Deep Discharge ..... (a) Discharge of a battery until 100% of the capacity is exhausted.  
..... (b) Discharge of a battery until the voltage under load drops below the specified final discharge voltage. (Over discharge).
9. Depth of Discharge ..... The ratio of discharge capacity vs. the rated capacity of a battery.
10. Discharge ..... The process of drawing stored energy out of a battery in the form of electrical power.
11. Energy Density ..... The ratio of energy that can be discharged from a battery to the volume of that battery measured in Watt Hours (WH) per cubic inch, or litre.
12. Float Service..... Method of use in which the battery and the load are connected in parallel to a float charger (or rectifier) so the constant voltage is applied to the battery continuously, maintaining the battery in a fully charged state and to supply power to the load from the battery without interruption or load variation.
13. Gas Recombination..... The process by which oxygen gas generated from the positive plates during the final stage of charging is absorbed into the negative plates, reducing the potential at the negative plates, so repressing the generation of hydrogen.
14. Impedance ..... The ratio of voltage variation vs. current variation in alternating (a.c.) supply.
15. Internal Resistance..... The term given to the resistance inside a battery, consisting of the sum of resistance of the electrolyte, the positive and negative plates & separators, etc.
16. Life Expectancy ..... Expected service life of a battery expressed in total cycles or time in float service in relation to a specified application.
17. Nominal Capacity ..... The nominal value of rated capacity. In valve regulated lead acid batteries nominal capacity is usually measured at the 20 hour rate, although higher rate discharge types have their nominal capacities given at the 10 hour rate.
18. Nominal Voltage..... The nominal value of rated voltage. In lead batteries, nominal voltage is 2 volts per cell.
19. Open circuit Volts..... The voltage of a battery which is isolated electrically from any external circuit, i.e. the voltage is measured in a no load condition.
20. Parallel Connection ..... Connection of a group of batteries by interconnecting all terminals of the same polarity, thereby increasing the capacity of the battery group but not increasing voltage.
21. Recovery Charge ..... The process of charging a discharged battery to restore its capacity in preparation for subsequent discharge.
22. Sealed..... The word "Sealed" is used as a relative term when referring to cells in NP batteries compared with open vented free electrolyte types.
23. Self Discharge ..... Loss of capacity without external current drain.
24. Series Connection..... Connection of a group of batteries by sequentially interconnecting the terminals of opposite polarity thereby increasing the voltage of a battery group but not increasing capacity.
25. Shallow Discharge ..... Discharge of a battery in which discharge is less than 50% depth of discharge. (D.O.D.)
26. Shelf Life ..... The maximum period of time a battery can be stored, under specified conditions, without needing supplementary charging.
27. Standby Service ..... General term for an application in which the battery is maintained in a fully charged condition by trickle or float charging. Synonymous with Float Service.
28. Trickle Charge..... Continuous charging by means of a small current designed to compensate for self discharge in a battery which is isolated from any load. For valve regulated lead acid batteries, constant voltage charging is common.
29. Charged Volume..... The power returned to the battery by charging as a percentage of the power taken out during discharge.
30. VPC (vpc)..... Term for volts per cell.



## INDEX

---

- Abnormal, 23
- Abnormally, 8,24
- ABS, 28
- Absorbed, 29
- Absorbent, 28
- Accelerated, 27
- Accept, 8, 23
- Acceptance, 2, 10, 23
- Accepted, 24
- Accidental, 28
- Accuracy, 23
- Accurately, 23
- Acid, 1, 4, 5, 8, 10, 13, 17, 18, 19, 29
- Activity, 25
- Adequate, 21, 28
- Adhesive, 28
- Adjusted, 23
- Adjusting, 23
- Adjustment, 23
- Adjustments, 23
- Adverse, 10
- Advisable, 28
- Advised, 21, 28
- Age, 24
- Ages, 28
- Air, 1, 28
- Alarm, 2, 28
- Allow, 28
- Alloy, 8
- Ambient, 2, 5, 9, 10, 11, 22, 25, 27, 28
- Ampere, 5, 29
- Amperes, 29
- Ampere hours, 5, 22, 26, 29
- Apparent, 27
- AQAP, 2
- Atmosphere, 28
- Autonomy, 7
- Avoid, 25, 28
  
- Bank, 28
- Banks, 28
- Bathe, 28
- Bloc, 7
- Block, 20, 21
- Bloc's, 7
- BS, 1, 2
- Busbars, 28
  
- Cable, 2
- Cables, 28
- Cadmium, 26
- Calcium, 8
- Calcium alloy, 1, 8
- Capacities, 28, 29
- Capacity, 1, 2, 3, 5, 7, 8, 9, 12, 17, 19, 21, 24, 27, 29
- Care, 17
- Cell, 5, 7, 11, 13, 19, 22, 23, 24, 25, 27, 29
- Cells, 7, 21
- Charge, 2, 8, 10, 17, 18, 19, 23, 24, 26, 27, 29
- Charged, 12, 13, 17, 19, 21, 22, 23, 26, 29
- Charger, 13, 18, 19, 20, 23, 24, 25, 29
- Chargers, 13, 21
- Charging, 10, 13, 14, 15, 16, 17, 18, 19, 20, 21, 22, 23, 24, 25, 26, 27, 28, 29
- Chemical, 29
- Classified, 1
- Clean, 28
- Cleaning, 28
- Cloth, 28
- Combine, 1
- Compensate, 29
- Compensated, 25
- Compensation, 22, 25, 28
- Conductive, 28
- Confined, 28
- Constant, 5, 7, 13, 17, 18, 19, 20, 21, 22, 23, 24, 29
- Contact, 28
- Contaminants, 1
- Control, 2, 21
- Controlled, 13
- Cool, 10
- Cooling, 28
- Corrosion, 27
- Corrosive, 27
- Cycles, 1, 27, 29
- Cyclic, 1, 5, 18, 20, 22, 25, 27, 28, 29
  
- Damage, 8, 17, 23, 28
- Damaged, 8
- Dampened, 28
- Dangerous, 1
- Deep, 1, 2, 8, 24, 29
- Demand energy, 21
- Density, 1, 29
- Depth, 1, 12, 27, 29
- Deterioration, 2
- Detrimental, 10
- Discharge, 1, 2, 5, 6, 7, 8, 9, 12, 22, 24, 27, 29
- Discharged, 5, 8, 22, 23, 24, 26, 27, 28, 29
- Discharges, 28
- Discharging, 29
- Dismantle, 28
- Disposal, 28
- Dry, 10
- Drying, 27
  
- Efficiency, 1, 7, 13, 26
- Efficient, 1, 19, 28
- Electrochemical, 25, 28
- Electrodes, 27
- Electrolyte, 1, 27, 28, 29
- Emergency, 2
- EN, 2
- Enclosure, 21, 28

Enclosures, 21  
 End, 5, 7, 27, 28  
 Energy, 1, 21, 22, 24, 28, 29  
 Environmental, 21  
 Equalisation, 28  
 Equalising, 17  
 Exceeds, 1, 5, 21, 28  
 Excellent, 2  
 Excursions, 10  
 Expectancy, 29  
 Expected, 1, 21, 27, 29  
 Eye, 28

Fall, 5, 23  
 Falls, 25  
 False, 24  
 Fastened, 28  
 Faston, 4  
 Fibre, 1  
 Final, 5, 7, 8, 22, 29  
 Fire, 2, 28  
 Float, 1, 5, 7, 19, 22, 23, 24, 25, 27, 28, 29  
 Floating, 11

Gas, 1, 29  
 Gases, 27, 28  
 Gels, 1  
 Generate, 28  
 Generated, 1, 27, 29  
 Gloves, 28  
 Gradient, 28  
 Gradients, 28  
 Grid, 8  
 Grids, 1

Handling, 28  
 Harsh, 18  
 Heat, 21, 23, 25, 28  
 Heating, 23  
 Hydrogen, 29

IEC, 1  
 Ignitable, 28  
 Immediate, 28  
 Impregnated, 28  
 Incinerate, 28  
 Initial, 13, 19, 22, 23, 24  
 Initiate, 24  
 Installations, 28  
 Insulated, 28  
 Insulating, 21  
 Insulator, 10  
 Interconnecting, 29  
 ISO, 2

Kills, 28

Lead, 1, 4, 5, 8, 10, 13, 17, 18, 19, 29  
 Leakage, 1  
 Life, 1, 2, 5, 8, 9, 10, 11, 13, 18, 20, 25, 27, 28, 29  
 Load, 7, 8, 19, 21, 23, 27, 28, 29  
 Load Sharing, 21  
 Local, 28  
 Loop, 28  
 Loses, 24  
 Loss, 1, 27, 29  
 Lost, 27

Maintained, 27, 29  
 Maintaining, 19, 29  
 Maintenance, 1, 5, 28  
 Maintenance Free, 28  
 Medical, 2, 28  
 Modules, 20  
 Monitor, 28  
 Monitoring, 24  
 Multi-stage, 24

Nickel, 26  
 Non-Spillable, 1

Oils, 28  
 Organic, 28  
 Orientation, 1  
 Overcharge, 17, 18, 19, 25  
 Overcharging, 21  
 Over Discharge, 8, 24, 29  
 Oxygen, 29

Paint, 28  
 Panels, 21  
 Petrol, 28  
 Polyethylene, 28  
 Polypropylene, 28

Quality, 2

Rate, 2, 5, 8, 9, 17, 27, 29  
 Rated, 2, 5, 19, 24, 29  
 Rates, 5, 6, 8, 26  
 Rating, 5  
 Recharge, 1, 19, 23  
 Recharged, 8, 27  
 Recharging, 10  
 Recombination, 1, 29  
 Recombined, 27  
 Recombines, 1  
 Recover, 8  
 Recovered, 19  
 Recovery, 2, 24, 29  
 Rectifier, 29  
 Recycling, 2, 23  
 Regime, 18, 24

Regulated, 1, 4, 5, 13, 17, 18, 19, 20, 21, 22, 29  
 Regulation, 23  
 Regulations, 1  
 Reseal, 1  
 Resin, 28  
 Resistance, 8, 12, 13, 24, 28, 29  
 Resistive, 21  
 Rubber, 28  
 Rupture, 28  
  
 Safe, 1, 20, 28  
 Safest, 1  
 Safety, 28  
 Self, 2, 9, 29  
 Self Discharge, 2, 9, 24, 29  
 Separator, 1  
 Separators, 29  
 Set, 19, 23, 25  
 Setting, 28  
 Severe, 8, 17  
 Shelf, 2, 9, 10, 29  
 Shock, 28  
 Short, 19, 20, 23, 25  
 Shorten, 18  
 Silica, 1  
 Skin, 28  
 Soaked, 28  
 Solar, 2, 21  
 Soldering, 28  
 Solvents, 28  
 Sparks, 28  
 Stage, 13, 19, 22, 23, 24, 29  
 Stages, 24  
 Stand, 28  
 Standby, 1, 2, 7, 19, 20, 22, 23, 24, 25, 27, 28, 29  
 Storage, 2, 9, 10, 24  
 Stored, 9, 10, 22, 24, 28, 29  
 Storing, 29  
 Sulphate, 10  
 Sulphation, 8, 10  
 Sunlight, 21  
 Suspension, 1  
  
 Taper, 13, 18  
 Temperature, 2, 5, 9, 10, 11, 22, 25, 27, 28  
 Temperatures, 2, 9, 10, 11, 21, 22, 24, 25, 26, 27, 28  
 Thermally, 25  
 Thinners, 28  
 TIPS, 28  
 Top, 5, 10, 24  
 Top charging, 10, 24  
 Touching, 28  
 Trickle, 29  
 Undercharge, 25  
 Undercharging, 23  
  
 VA, 7  
 Valve, 1, 4, 5, 13, 17, 18, 19, 29  
 Vibration, 28  
 Volt, 7, 20, 24  
 Vpc, 7, 23, 24  
  
 WAC, 7  
 Wash, 28  
 Water, 1, 27, 28  
 Watt, 29  
 Watts, 7

## NOTES

---

Further technical information available on request:

- Transportation of Yuasa Batteries by Air, Sea or Road
- Effect of High Temperature on Battery Float Life
- Gas Production in Valve Regulated Lead Acid (V.R.L.A.) Batteries
- Safe Handling of product (C.O.S.H.H.)
- NP Batteries/BS6290 Part 4
- Shelf Life, Self Discharge and Top Charging
- Pre-Installation Battery Checks
- Recovery of Sulphated Batteries
- Effects of Altitude on Valve Regulated Lead Acid (V.R.L.A.) Batteries
- Ventilation
- Environmental Requirements of NP and UXL Batteries on Float Standby
- Environmental Safety of NP Batteries
- Standards
- Float Service Life of NP Batteries
- Statement on Service Life
- Shock and Vibration Tests on NP Batteries
- Enhanced Performance and Life Through Correct Charging
- Torque Settings
- NPL Short Form
- NPC Short Form
- NPH Short Form
- YPI-2 Impedance/Comparator Test Meter
- Date Code Interpretation
- Product Safety Data Sheet
- Connector Selection Chart